

DEVELOPMENT HISTORIC BUILDINGS
ACCESSIBILITY
COMMUNITY BUS JOBS
POTENTIAL NEIGHBORHOOD
TRANSPORTATION ROAD DIVERSITY
PEOPLE
DEVELOPMENT HISTORIC BUILDINGS
ACCESSIBILITY
COMMUNITY BUS JOBS
POTENTIAL NEIGHBORHOOD
TRANSPORTATION ROAD DIVERSITY
PEOPLE



Cleveland City Planning Commission

105
93

Linking HEALTHY, EQUITABLE,

and SUSTAINABLE Communities



Photograph of mural on E 105th Street

ACKNOWLEDGMENTS

The City of Cleveland thanks the Cleveland Planning Commission staff and Technical Advisory Commission for their contributions of time and expertise to this project.

City of Cleveland Planning Commission Staff

Freddy L. Collier, Jr.	Director
Marka Fields	City Planner
Kim Scott	City Planner
Sharonda L. Whatley	District 6 Neighborhood Planner
Don Angus	City Planner

Technical Advisory Committee

City of Cleveland

Valarie McCall	Chief of Government Affairs
Edward Rybka	Chief of Regional Development
Michael McGrath	Safety Director
Calvin Williams	Chief of Police
Rob Mavec	Commissioner of Traffic Engineering
Regina Leverett	Civil Engineer, Traffic
Ron O'Leary	Director of Building and Housing
Karen Lopez	Building and Housing, Admin. Officer, Code Enforcement
Mike Cox	Director of Public Works
Blaine Griffin	Director of Community Relations
Natoya Walker	Mayor's Office, Special Assistant to the Mayor, Acting Director of Health Dept.
Charles Slife	Regional Development Assistant
Andy Cross	Consulting Engineer
Matthew L. Spronz	Director, Office of Capital Projects
Jenita McGowan	Chief, Mayors Office of Sustainability
Michael Cosgrove	Assistant Director of Community Development
Tracey Nichols	Director, Economic Development
David Ebersole	Assistant Director, Economic Development

Jane Fumich
Jamie DeRosa
Kristin Hall

NOACA

Ryan Noles
Melissa Thompson

ODOT

John Motl

RTA

Maribeth Feke
Valerie Shea

CDC's

John Hopkins
Jeanetta Price
Tim Tramble
Denise VanLeer

Chris Ronayne
Michael Fleming
John Anoliefo

Other

Justin Fleming

Jacob VanSickle
Cheryl Stephens
Charles Slife
Jim Rokakis

Director, Department of Aging
Commissioner of Real Estate
Mayor's Office of Sustainability

Transportation Planner
Active Transportation Engineer

District SRTS Coordinator

Director of Programming & Planning
Planning Team Leader

Buckeye Shaker Square Dev.Corp.
Executive Director, Union Miles Dev. Corp
Director, Burten Bell Carr Dev. Corp.
Executive Director, Fairfax Renaissance
Dev. Corp.
President, University Circle, Inc.
Director, St. Clair -Superior Dev. Corp.
Director, Famicos

Director of Real Estate,
Cleveland Neighborhood Progress
Executive Director, Bike Cleveland
County Land Bank
Regional Development Assistant
Director, Thriving Communities Institute,
Western Reserve Land Conservancy

Kyle Dreyfuss-Wells
Matt Haren

John Habat
Ziona Austrian
Cathy Belk
Gregory L. Brown
Evelyn Burnett

Randy McShepard
Tom O'Brien

Manager of Watershed Programs, NEORS
Director of Policy and Program Initiatives,
Habitat for Humanity
President/CEO, Habitat for Humanity
Cleveland State
President, Jumpstart
Executive Director, Policy Bridge
VP of Community Engagement,
Cleveland Neighborhood Progress
VP, Public Affairs, RPM International
Executive Director, Neighborhood Connections

CONTENTS

01 COLLECTIVE VISION

- 07 New Momentum
- 09 Changing City
- 16 Renewed Creativity
- 20 Connected Corridor

02 COMMUNITY BUSINESS MODELS

- 28 E 105th & Superior
- 30 New Economy Neighborhood
- 32 Woodhill Estates
- 34 Buckeye & Woodhill Road
- 36 Kinsman-Union & 93rd Street

03 DESIGN GUIDANCE

- 42 Designing the #10
- 54 The Street
- 58 Bicycle Concepts
- 64 Implementation

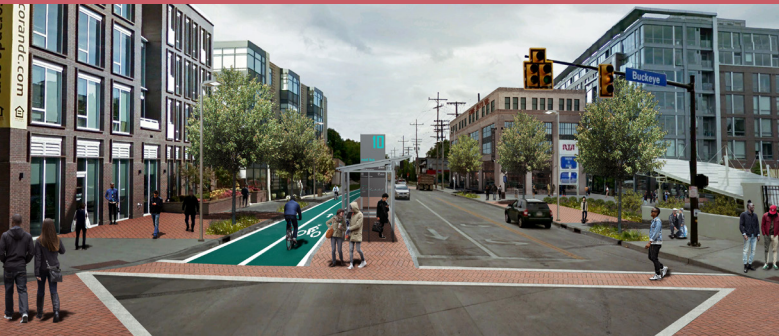



Whether the economy is good or bad, public dollars are always limited and must be leveraged. One of the key objectives of my Neighborhood Transformation Initiative is to focus new tools, programs, and resources in inherently disadvantaged communities. Therefore, the principle of "Equity" is at the forefront of the effort. My Neighborhood Transformation Initiative will require the City of Cleveland and our key partners invest in areas that have been prioritized by the City of Cleveland.

This effort goes beyond the targeted dispensation of public and private resources; this effort focuses on strategic alignment and acting on a shared value proposition. By working with select partners who share the value proposition of "equitable neighborhood development", we can ensure that everyone benefits from Cleveland's growth. Coordinating our collective resources and focusing our efforts within the same geographies will allow us to have the greatest impact. The strategy is inclusive of community input through strategic planning efforts such as The Thrive 105-93 Initiative. The Thrive 105/93 initiative sets a new course for the East 105th/ East 93rd Street Corridor by identifying opportunities for investment and connecting those opportunities through quality, efficient, transit options. Transportation will be an important component of our efforts to ensure that all Clevelanders have access to the jobs and other amenities throughout our City. These strategies will be utilized as a guide to direct limited resource to target geographies and ensure that they address neighborhood desires while taking into account changing market conditions. Our ultimate goal is to stop decline, Stabilize Neighborhoods, and build for the Future.

Frank G. Jackson
Mayor
City of Cleveland



The targeted reinvestment approach identified as part of the Mayors Neighborhood Transformation Initiative is rooted in the CORE Redevelopment Strategy developed by the Cleveland Planning Commission. The Strategy is built on the idea of "capitalizing on our existing strengths" and ensuring that "prosperous areas of our City are connected to less prosperous communities". Commercial Corridors such as the East 105th East 93rd Street Corridor provides the connectivity between thriving neighborhoods and neighborhoods of opportunity.

Our strategic focus is on "Fringe" neighborhoods just outside of growth zones. These "Fringe" areas consist of Cleveland's most challenged neighborhoods; however they represent communities of opportunity due to their rich assets and abundance of land resources. The Jackson administration seeks to build communities that are healthy, equitable, and sustainable. This will require addressing social, economic, and environmental conditions that adversely impact our neighborhoods. Consistent with the Mayors vision, the Thrive 105-93 effort seeks to drill down into specific geographies within neighborhoods flanking the corridor. Driven by the principle of equity, we want to ensure that residents have a fair opportunity to obtain their full potential. Due to systemic social, economic, and environmental issues related to jobs, education, housing, safety, and health these areas have suffered disproportionately and will need deliberate focus to create opportunity for residents to thrive. North/South transportation connections will be critical to link residents in some of Cleveland's most challenged communities to opportunities that are a walk, bus ride, or bike ride away. Many of the areas along the East 93rd East 105th corridor contain physical assets such as vacant land, view sheds, transit investments, proximity to park amenities, and significant institutional expansions. These assets will serve as the building blocks for reinvestment along the corridor and will provide the demand for improved transportation access connecting the many neighborhoods along the corridor.

Freddy L. Collier, Jr.
Director
Cleveland City Planning Commission

01

COLLECTIVE VISION

“ This plan should be a 'playbook' for the corridor, describing guidelines for development, public space and transit improvements that act as a coordinated catalyst for growth and vibrancy.

Freddy L. Collier, Jr.
Director, Cleveland City Planning Commission



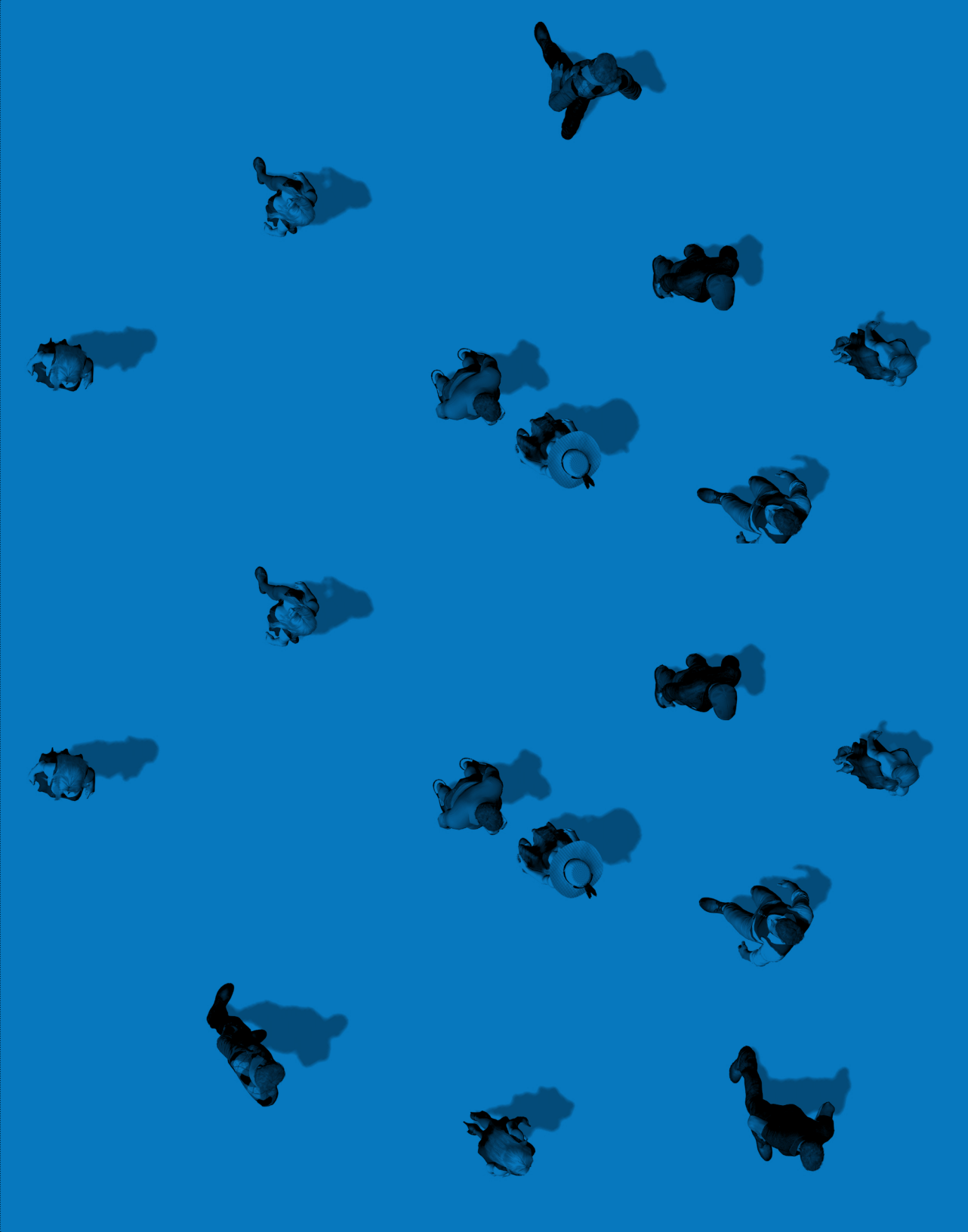

+ This plan seeks to unite the aspirations of each community into a coordinated playbook that each can follow, work towards and benefit from.

+ New Momentum

With grant funds from the US Department of Transportation (USDOT) Tiger program and its own matching contribution, the City of Cleveland set out to define a collective vision for the neighborhoods connected by the # 10 Bus route. This corridor follows E 105th Street south from Bratenahl through St. Clair/Superior, then through Glennville, University Circle, then south to Fairfax where it connects to Woodhill Rd via Quincy Street. The corridor then connects southward through Woodhill, Buckeye, Kinsman, and Union Miles. Overall the one bus route covers 7 miles in length. It crosses 9 high volume bus routes, 2 rapid lines and the health line. Each of these neighborhoods have their own story, their own context, and many have charted their own course forward into the 21st century independently.

This plan seeks to unite the aspirations of each community into a coordinated playbook that each can follow, work towards and benefit from. The plan identifies ways in which communities along route #10 can work together to attract new investment and foster a renewed spirit of entrepreneurship all while emphasizing their neighborhood's unique citizens, attributes, and history.

The plan seeks to amplify the specific narrative of each community through physical improvements, programs and policies that are best achieved through support of common goals. With this intent, the plan began by asking,

How can new **transit**, new **development** and new **public spaces** along East 105th Street, Woodhill Rd, and East 93rd Street help:

- + Provide better access to jobs?
- + Make people feel safe?
- + Support healthy lifestyles?
- + Build community pride?

In addition to these goals, the City of Cleveland approached unlocking neighborhood potential through strategic attention to community health, equity and sustainability.

Health-

Lack of access to prenatal care, childcare, fresh foods and safe means of play and exercise can place chronic stresses on individuals and their community as a whole. A recent study from the VCU Center on Society and Health and Robert Wood Foundation found that a child born in Glenville has a life expectancy 12 years shorter than a child born in Lyndhurst, 10 miles away. Each recommendation must have a connection to improving public health.

Equity-

Rather than spreading investments equivalently regardless of impact, an equitable community invests strategically to leverage the greatest benefits for all. Recommendations will seek to identify strategic targets that can maximize impacts from an individual investment.

Sustainability-

Sustainable communities are as much about turning liabilities into assets as they are employing green infrastructure and walkable, transit oriented practices. Recommendations will identify infrastructure that supports place-making, environmental quality and economic development simultaneously.

These principles shaped discussions, workshops and recommendations. They are the keys to catalyzing new growth and new vitality, and they define the path through which #10 communities will thrive.

Corridor at a Glance:

- + 7+ miles
- + 9 neighborhoods
- + 9 community development corporations
- + 10 major bus routes crossed
- + 3 major Rapid Transit routes crossed

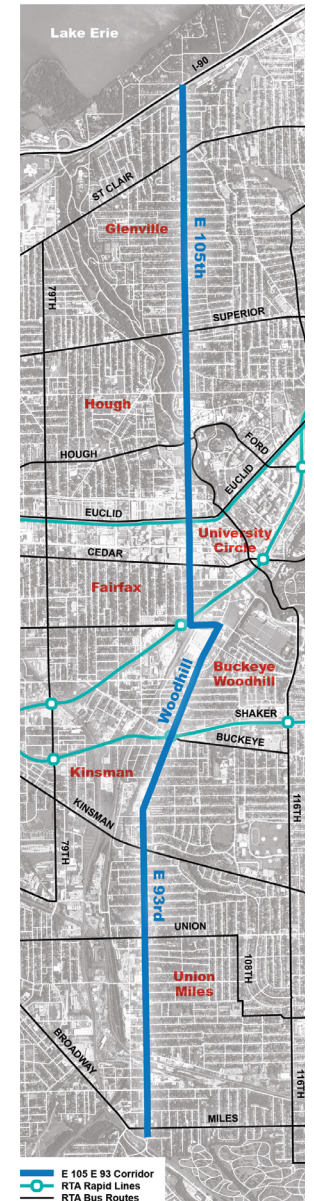

Diagram depicting the corridor and its intersection with Cleveland neighborhoods.

E 105 E 93 Corridor
RTA Rapid Lines
RTA Bus Routes

+ Changing City

Core Redevelopment Strategy

The mayor's core redevelopment strategy identifies the City of Cleveland's economic development engines and the key corridors that link them. E 105th and E 93rd streets connect the catalysts of the lakefront and University Circle with neighborhoods on the rise.

Existing Planning Efforts

A number of strategies, plans, projects, and studies have informed planning interventions along the E 93 – E 105 corridor and in surrounding neighborhoods.

At the southern end of the corridor, the **2004 Union Miles Neighborhood Master Plan** concentrated new development at the Miles Avenue / E 131st St intersection, introduced buffered bicycle lanes, and improved pedestrian crosswalks and visibility.

The **2012 Miles Avenue Streetscape Plan** encouraged the rehabilitation and redevelopment of vacant and dilapidated properties, defined a mixed-use and industrial district at the Broadway / Miles Ave area, and suggested a business redevelopment district.

The **Kinsman Road Neighborhood Studies** proposed multi-modal accessibility, a traffic circle, and urban design interventions in the area.

Cleveland's Core Redevelopment Strategy

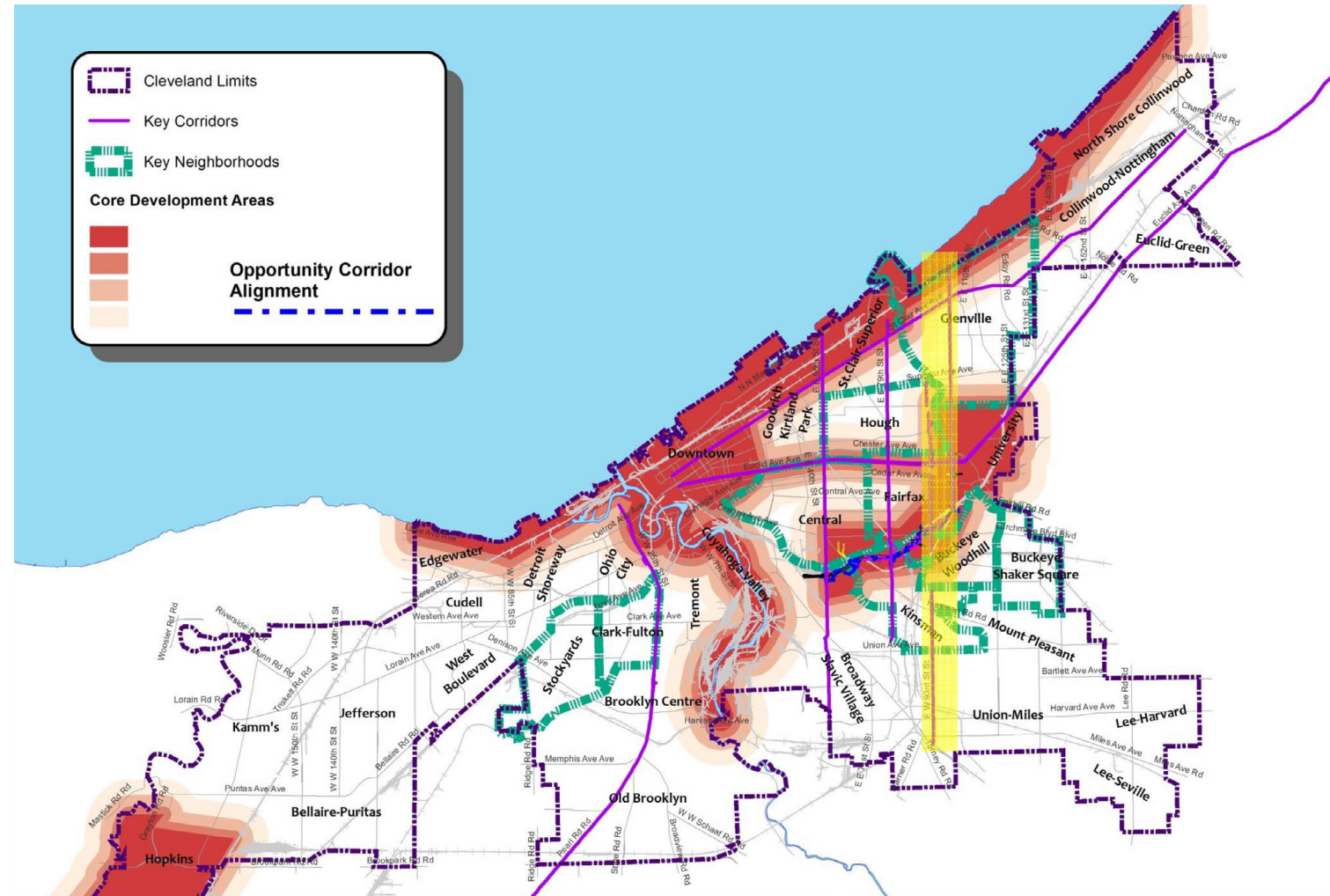

Diagram depicting the Mayor's core redevelopment areas and the relationship to the corridor.

Towards the center of the corridor, the **2010 Buckeye Woodhill Neighborhood Development Plan** proposed inter-generational transit-oriented development; suggested improvements to pedestrian, transit, and bicycle facilities; and encouraged investments into water pollution reduction, and public realm and safety improvements.

The **2014 Fairfax Strategic Investment Master Plan** aimed to reestablish a commercial center at the E 93rd / Cedar Ave intersection; to improve the pedestrian environment, open spaces and parks; and sought establishment in an arts and culture district, a comprehensive housing initiative, and a new Fairfax Recreational Center.

The **2008 Heritage Lane Study** sought to re-engage Rockefeller Park; widen E 105th St, realign East Blvd and the one-way VA Drive, eliminate the existing traffic circle, and to develop multi-modal bicycle-friendly streets.

The **2008 Village Project Charrette** proposed housing development at E 105th Street, University Circle, and Tanner Court; enhancements to the streetscape and parks; and a land bridge connection over the Rockefeller shore way.

The **2004 Garrett Square Revitalization Strategy** encouraged retail uses and higher-diversity higher-density residential development along with shared parking with aligned entrances and exits.

The **2009 Superior 5 Study Area** suggested increased landscaped areas and infill development, new parks, additional intersections, unified pedestrian-friendly landscaping and crosswalks, and new bike paths.

The **St. Claire Avenue Corridor Study** proposed strategies for rehabilitation, demolition, preservation of buildings, and changes to land use; bike lanes and facilities, vegetated public open space, pedestrian facilities, and bus rapid transit (BRT) shelters and service; as well as projects that provide access to fiber optic technology, increased parking, changes in lane widths, and street repairs.

The **2015 LIHTC Primary Market Area Market Study** also concluded that a new housing unit mix would be required.

The **Opportunity Corridor project**, managed by the Ohio Department of Transportation District 12, the City of Cleveland, and Greater Cleveland Partnership, will redevelop roadway of the E 105th St Corridor, Norman Ave to E 93rd St, E 93rd St to Interstate 490 as a spur for reinvestment into the North Broadway, Central Cleveland, Kinsman, Buckeye-Woodhill, Fairfax, and University Circle neighborhoods.

Demographics

The median age within the corridor tends to be significantly lower than the county and state median age. The central section of the corridor has a particularly low median age (approximately 10 years younger than county and MSA levels), due primarily to the presence of Case Western Reserve University. While population in the Greater Cleveland area has declined slightly since 2000, the corridor has declined at an accelerated rate. The northern section has declined by -3.2% annually since 2000, approximately 12 times the rate of the metro area. The central (-1.8%) and southern (-2.9%) sections have declined at approximately seven and ten times the rate of the metro area respectively.



Illustrations of corridor amenities from previous studies.



Aerial photograph of the University Circle and Cleveland Clinic area. This is the hub of economic activity in East Cleveland and a driver of local employment.

While median household income in the corridor is relatively consistent with the City of Cleveland (\$26,476), it falls short of half of the metro area (\$50,124), county (\$44,009) and state (\$49,011) levels of income. According to the US Census, median household income in the United States is approximately \$54,000, three times larger than the median household income in the corridor. 2015 median household incomes in Southern (\$19,911), Central (\$18,384), and Northern (\$19,775) Cleveland fall below the median city income.

Employment

Over the 12-year period, the number of people traveling from outside into Cleveland for employment has decreased by approximately 21,000 people. It appears that a majority of these workers are now living in or leaving Cleveland for employment, as each of these groups have grown by over 20,000 employees.

Despite a significant decline in median sales price during the housing crisis, homes within the corridor are gradually recovering from the Recession. In recent years, the Fairfax neighborhood has seen an accelerated growth in home sales price compared to other neighborhoods in the corridor. Fairfax is located in the central region on the west side of the corridor and is the closest of the corridor's neighborhoods to downtown Cleveland. The University neighborhood was briefly affected by the Recession in 2009 but was able to recover quickly and exceed pre-Recession price levels in subsequent years. Sources indicate that an urban area has a home replacement rate of approximately two homes per 1,000 people, implying that Ohio is approaching national averages while the City of Cleveland and Cuyahoga County are underperforming in terms of home replacement rate. A lack of modern housing can constrain economic growth.

Multi Family Housing

Multi family housing has seen an overall increase in inventory and occupancy between 2007 and 2015, with every study area reporting a positive growth rate. New construction of housing stock has been more represented in Downtown Cleveland relative to other study areas.

Office

The inventory of office space has seen increases in all three sections of the 105th Corridor, as well as in Downtown Cleveland and in the State of Ohio. The City of Cleveland has seen the greatest decline in office inventory space. Office occupancy generally followed inventory trends, with Downtown Cleveland being the only study area enduring an opposite trend over the study period. Net absorption remained highest for the City of Cleveland, Downtown Cleveland and the Central Section of the 105th Corridor. All other study areas experienced decreases in their total net absorption.

Industrial

Industrial inventory remained relatively unchanged compared to the other categories of real estate analyzed. The City of Cleveland experienced the greatest decline in industrial space, followed by Cuyahoga County and the Cleveland MSA. All other study areas saw industrial space remain relatively stable or increase slightly. Industrial Occupancy also remained relatively unchanged between 2007 and 2015. The City of Cleveland experienced the sharpest decline in industrial occupancy space, while the Central Section of the 105th Corridor experienced the

greatest increase in industrial occupancy. Net absorption trends experienced the greatest volatility in the Cleveland-Elyria MSA, which experienced a greater absolute and percentage decrease than any other study area. Cuyahoga County and the Southern Section of the E 105th Street Corridor also experienced decreases in total net absorption between 2007 and 2015.

Retail

The inventory of retail space saw increases in every study area, with Downtown Cleveland, as well as the three sections of the E 105th Street Corridor experiencing the fastest growth rate in retail inventory space. Occupancy trends followed inventory trends, with every study area in Ohio seeing increases in retail occupancy. Despite increases in inventory and occupancy, The State of Ohio as well as the Cleveland MSA, Cuyahoga County, and the central section of the E 105th Street Corridor saw decreases to their net absorption of retail space. Despite increases in both retail inventory and occupancy, the three sections of the 105th Corridor remain underserved on a retail space per capita basis relative to the other study areas.

In 2015, there was approximately 23 square feet of occupied retail space per capita in the corridor, significantly lower than Cleveland (73 sf), Cuyahoga County (62 sf), and Ohio (58 sf). While the regional factors reflect generally “overbuilt” retail markets, the corridor is underserved in terms of contemporary retail inventory. Employment data suggests the northern section has more than doubled its concentration of retail trade employment from a location quotient of 0.59 in 2007 to 1.38 in 2014. This increase in

employment may be due in large part to the generally stable existing retail node at the intersection of St. Clair Ave and E 105th Street. The southern section of the corridor accounts for approximately 8.4% of all industrial inventory in the City of Cleveland. In addition, the southern section has remained above 95% occupancy since 2007 according to CoStar, signifying a stronger industrial market in the southern portion of the corridor. The concentration of industrial employment in the southern section has also improved as construction, manufacturing, and transportation / warehousing have all increased employment concentration to levels higher than state averages. Opportunities to pursue infill industrial, wholesale, and flex (office / showroom / warehouse) should be considered for this larger area, including connections to the Opportunity Corridor.

Since 2000, while Cleveland Metropolitan Area populations have declined at an average annual rate of -0.3%, the northern, central, and southern sections of the corridor have declined at accelerated rates (-3.2%, -1.8%, and -2.9%, respectively). The corridor has experienced a significant and growing daily inflow of in excess of 32,300 workers within the corridor (primarily in the central section), growing at a 14% annualized rate since 2009. Approximately 56% of all incoming workers in the central section of the corridor earn more than \$3,333 per month (up from 44% in 2009 and 33% in 2002), compared to 55% downtown and 55% across the entire city. While the northern (33%) and southern (46%) sections have lower high income jobs, they have increased significantly since 2002. As of 2015, average home sales prices within the corridor (\$34,000) remain

significantly below city averages (\$128,000), and the City appears to be having difficulty in supporting rates of new housing unit construction that would exceed basic thresholds for housing unit replacement (2 units per 1,000 people per year). Lack of inventory growth at all price levels is a constraint on value. At the same time, apartment rental



Example of former residential property that can be repositioned for future employment.



Improving the relationship between commercial activities and the public realm will be critical to building economic momentum.



The Heritage Lane section of E 105th Street extends economic activity north of University Circle.

rates within the corridor are consistent with city averages and have grown at an average annual rate of 1.4% since 2000. The implication being that while the buyer's market remains in a difficult place (even in the central section), the rental market appears to have strengthened, and may be better positioned (than for-sale units) to support investment, (particularly in the central section).

Stressors on Health

The E 105th-E 93rd street corridor faces a lack of amenities that support healthy lifestyles. While the East Side Market is planned for re-development, not one fresh food-oriented grocery store was available to residents along the entire seven-mile length of the E 105 – 93 St corridor during 2016 surveys. A lack of healthy food choices burdens families with poorer nutrition, longer commutes and increased spending to access fresh food for daily consumption. Among other options, residents have expressed that these stressors can be lessened by increasing distribution and access to community produce gardens on vacant land, by facilitating economic development opportunities for providers of healthy food choices along the corridor, and by supporting the proliferation of farmers markets on evenings and weekends.

Additionally, a lack of affordable child care facilities along the corridor limits the ability of parents to care for their children while also working during business hours. Low- to medium-income households are doubly challenged in trying to balance their need to work full time, if not more than full time, in order to meet baseline financial needs, with access to affordable child care during working hours. These pressures can be lessened by increasing options for affordable child care funded publicly or by fees, by building upon the spatial and personnel resources of community and religious institutions to offer care during working hours and after school, and by increasing employment options along the corridor to lessen commute times for parents.

Community-driven design can encourage the growth of healthier, safer, age-friendly communities. The University of Minnesota's Metropolitan Design Center's "Design for Health" project reports that design can lead to improved accessibility, increased physical activity, social capital and cohesion, access to fresh food, clean air and water, and public safety are vital in designing for healthier communities.

The American Public Transportation Association's "Crime Prevention Through Environmental Design" report states that increased housing and transportation choices, opportunities for social participation, frequent communication and information, welcoming outdoor spaces and buildings, and opportunities for civic participation and employment can support residents in creating safer communities.

The World Health Organization's "Checklist of Essential Gestures of Age-Friendly cities" includes activity support venues and programming, pride of place, strategic circulation, and natural "eyes on the street" circulation as strategies that support communities for residents of all ages.

Your zip code can affect your life expectancy

If you travel less than ten miles from Cleveland's northeastern neighborhoods to more affluent eastern outer-ring suburbs, life expectancy can differ by as much as 12 years.

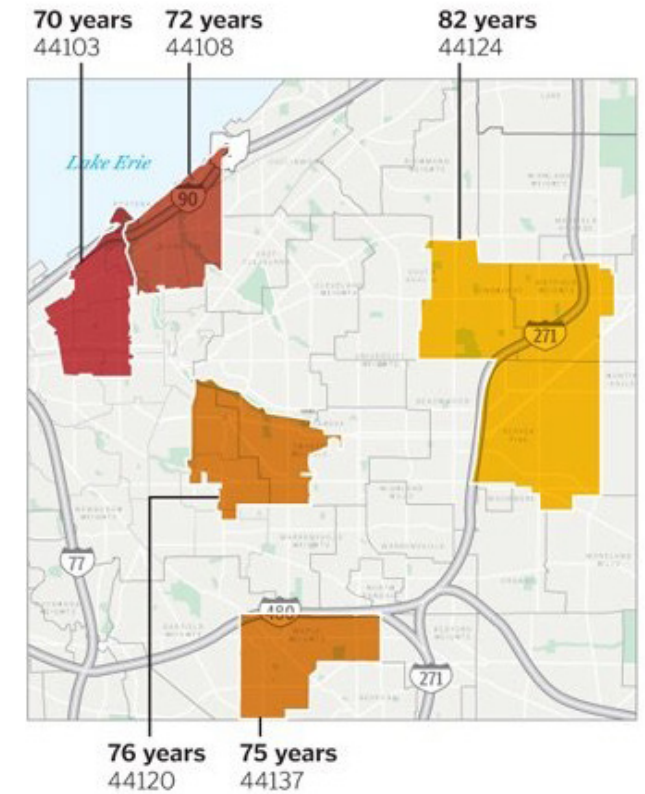

A June 2016 Cleveland.com article, based upon a VCU Center on Society and Health and Robert Wood Foundation study, highlights premature deaths amongst Glenville residents when compared to other Cleveland neighborhoods.



Diagram illustrating the co-benefits of priority design strategies and tactics.

+ Renewed Creativity

Through community meetings, stakeholder interviews, and open-house events, a sense of entrepreneurial creativity began to emerge. The following engagement activities created a setting where corridor communities could discuss their own ideas for their neighborhood's future:

- May, 2016 Technical Advisory Committee meeting #1
- June, 2016 Stakeholder interviews
- June, 2016 Neighborhood meeting series #1
- July, 2016 Surveys at community events
- August, 2016 Supplemental public meeting
- Sept, 2016 Creative Corridor event (Ingenuity Fest)
- October, 2016 Technical Advisory Committee meeting #2
- October, 2016 Neighborhood intercept meeting series #2
- Nov, 2016 Design workshop / Charrette
- January, 2017 Technical Advisory Committee meeting #3
- February, 2017 Neighborhood night engagements
- March, 2017 Public openhouse meetings series #3

Communities were asked a series of guiding questions in order to better understand interests, concerns, and priorities.

If you could add one thing to the corridor, what would it be?

RECREATION CENTER
 TRANSPORTATION BUSES EMPLOYMENT
 GREEN SPACES RETAIL BUSINESSES
 POLICE GROCERY JOB
 SCHOOLS MORE SAFETY BIKE
 PARKS PEOPLE

What is the corridor's greatest strength?

DEVELOPMENT HISTORIC BUILDINGS
 ACCESSIBILITY
 COMMUNITY POTENTIAL BUS JOBS
 DIVERSITY NEIGHBORHOOD ROAD PEOPLE
 TRANSPORTATION

What is the corridor's greatest weakness?

APPEARANCE
 UNEMPLOYMENT ROAD CONDITIONS
 LACK OF AMENITIES
 BLIGHT UNSAFE CRIME
 PERCEPTIONS LACK OF SCHOOLS
 VACANCY GROCERY

What makes you feel safe?

POLICE HOUSE ALERTNESS
 GOOD PEOPLE
 SECURITY NOT GOING OUT

Dear Neighborhood,

Do you think your neighborhood is a safe place?

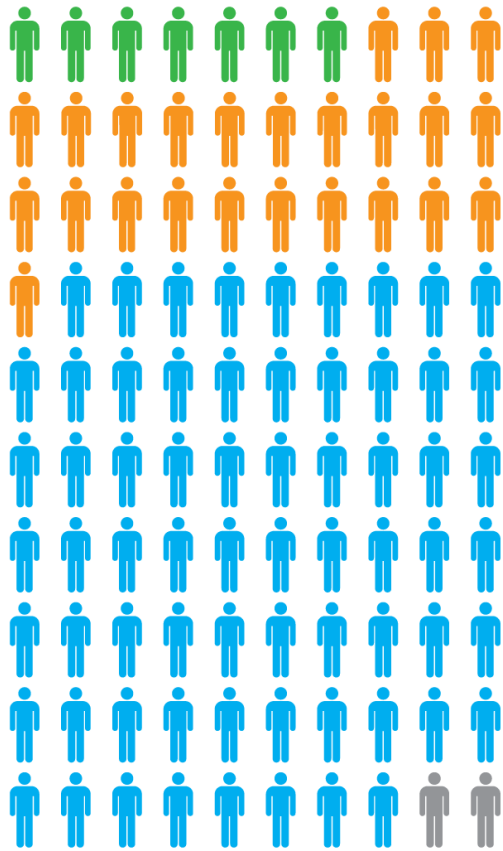

Yes (7%)
 No (24%)
 Sometimes (67%)
 No Answer (2%)

I like the fact that although the residents could have given up and moved away they continue to stick with us.
 We have the largest urban park in the state.
 I like the fact that although could have given up and moved continue to stick with us.
 What I like about 9610 miles is:
 - Open market
 - Easy access to neighboring streets
 - Neighborhood side streets
 I APPRECIATE THE DIVERSITY BECAUSE WE LEARN & GROW FROM EACH OTHER. I'VE LIVED IN THE COMMUNITY FOR 55 YEARS & HAVE BECOME FAMILIAR WITH THE...
 I'm looking forward to...
 I feel this community has some good leaders and the programs they have for young people are nice and empowering.
 The community has potential its a big community with a lot of dreams and people that will stand up for the dream.
 I appreciate the diversity because we learn & grow from each other. I've lived in the community for 55 years & have become familiar with the...
 I feel this community has some good leaders and the programs they have for young people are nice and empowering.
 The community has potential its a big community with a lot of dreams and people that will stand up for the dream.

Corridor's Greatest Strengths, Weaknesses, Adding One Thing

During workshops with communities along the corridor, communities identified accessibility, the residents, the neighborhood's potential and diversity as the greatest assets of neighborhoods along the corridor. Residents also responded that a lack of amenities and grocery stores, crime, land and building vacancy, unemployment, and perceptions about neighborhoods were the corridor's greatest weaknesses. When asked what one thing they would add to the corridor if possible, participants responded that more businesses, grocery stores, public safety, retail and employment would most improve their quality of life.

Public Safety

During workshops and intercept surveys with communities along the corridor, only 7% of residents responded that they thought of their neighborhood as a safe place. Many reported that they felt least safe after dark, and generally while walking on any street in their neighborhood. Residents expected that they might feel safer if their neighborhoods included "good people", improved street lighting, had regular police presence during the day and night, and reduced the number of vacant buildings and land parcels.



thrive
105-93

Linking Healthy, Equitable, & Sustainable Communities

Ingenuity Cleveland, AECOM & Partners present ...

Creative Corridor!

At IngenuityFest 2016: Awakenings

IngenuityFest & the Creative Corridor Event will be September 23-25 in the Saint Clair Superior Neighborhood, at E. 53rd and Hamilton Avenue. View artist-driven projects, participate in an interactive creation station & attend a panel on creative strategies to promote inclusion, artistry, entrepreneurship and quality of life in the E. 105th – 93rd corridor.

Creative Solutions Provided By:
Jennie Doran & Andrew Worm (Owners, Room Service Boutique and Founders, R/S Creative)
Steve Manka (Sculptor & Public Artist)
Dru McKeown (Architect & Creative Workforce Fellow, Architecture Office)

Panel Discussion: Creative Corridor Solutions
Featuring **Freddy Collier, Cleveland's Director of City Planning**
with Peter Lawson Jones, Civic Leader
Ryan Bouma, Landscape Architect and Urban Designer, AECOM
Peter Debelak, Founder, Soulcraft Cleveland
Nicole Delamotte, Cleveland Arts & Culture Writer
Dru McKeown, Steve Manka, Jennie Doran

Saturday September 24, 3:00-4:30 pm

Free transportation to the event provided by Westside Shuffle, at the following locations:

Cleveland Public Library, Union Branch
3463 E. 93rd St
Cleveland, OH 44104

Pick Up: (CPL to IngenuityFest) 1:30 pm
Drop Off: (IngenuityFest to CPL) 5:00 pm; 7:00 pm

Bethany Baptist Church
1211 East 105th Street
Cleveland, Ohio 44108

Pick Up (Church to IngenuityFest) 2:15 pm
Drop Off (IngenuityFest to Church) 5:00 pm; 7:00 pm

Learn more at ingenuitycleveland.com

IngenuityFest 2016: Awakenings
Friday Sept 23 5pm-1am
Saturday Sept 24 12 pm-1am
Sunday Sept 25 12pm-5pm
\$5/\$10wknd/FREE under 12 and corridor residents*
*arriving on West Side Shuffle from identified pickup locations

Images of public engagement events and or intercept materials used to solicit input.

thrive
105-93

Linking Healthy, Equitable, & Sustainable Communities

How can new **Transit**, new **Development** and new **Public Spaces** along East 105th Street, Woodhill Rd and East 93rd Street help:

- Provide better access to **Jobs**?
- Make people feel **Safe**?
- Support **Healthy** lifestyles?
- Build community **Pride**?

The Cleveland Planning Commission wants your help in planning future investment along the E105th – E-93rd street corridor.

We need your suggestions!

The planning process runs until **March 2017**.

There will be many chances to **participate**. Please come to meetings and **sign up** to receive information here:

Web: www.Thrive105-93.com
Twitter: @Thrive105_93
Facebook: <https://www.facebook.com/thrive10593/>
Instagram: thrive105_93

For more information, please contact:
Marka Fields, City Planning Commission, mfields@city.cleveland

Cleveland City Planning Commission
CITY OF CLEVELAND
Mayor Frank G. Jackson

Handwritten notes on map:
- "Walking along E 105th / E 93rd St."
- "At the bus stop"
- "Walking along my side street"
- "Other (please write when)"
- "After dark"
- "On the way home from school"
- "Middle of the day"
- "Other (please write when)"
- "Better lighting"
- "Fewer vacant buildings"
- "More neighborhood events"
- "Other (please write your suggestion)"

Most people have told us they only "sometimes" feel safe out in the community! So we want to know more about what makes you feel unsafe... and what should be done about it.

Please place an orange dot below **where you feel the least safe** in your neighborhood?

Walking along E 105th / E 93rd St.	At the bus stop	Walking along my side street	Other (please write when)
------------------------------------	-----------------	------------------------------	---------------------------

Please place an orange dot below **when you feel the least safe** along E105th – E. 93rd?

After dark	On the way home from school	Middle of the day	Other (please write when)
------------	-----------------------------	-------------------	---------------------------

Please place an orange dot below what would **most help you feel safer** along E105th – E. 93rd?

Better lighting	Fewer vacant buildings	More neighborhood events	Other (please write your suggestion)
-----------------	------------------------	--------------------------	--------------------------------------

Thank you for participating in the plan!

Vacant Land - From Liability to Asset

Community members identified the highly visible presence of vacant buildings and underutilized land as a significant barrier to improving the community. Vacancy patterns were analyzed to better understand how corridor enhancements could change perceptions. Data was gathered from the Western Reserve Land Conservancy’s 2016 “Cleveland Property Inventory” report and from the Cuyahoga County GIS portal.

3,832 buildings, along with 1,167 acres of land on 7,888 parcels lie vacant within a 10 minute walk (1/2 mile) of the corridor. These 7,888 vacant parcels amount to approximately 22% of land within a 1/2 mile radius of the corridor. Of these parcels, 87 acres are located within a five minute (1/4 mile) walk of rapid transit stations along the corridor, with 307.8 acres available within a 10 minute (1/2 mile) walk of the stations. Of the total 1,167 parcels, only 7 offer developmental potentials greater than 5 acres. Parcels greater than 5 acres are more flexible and easier to market for redevelopment and employment generation.

Large quantities of dispersed, un-programmed vacant land are a liability for residents. Without use within the daily lives of residents, neglected vacant land can lower property values in surrounding neighborhoods, be appropriated for potentially-criminal uses, or extend gaps in the safety of pedestrians and bicyclists.

However, vacant land can be transformed from liability to asset, helping residents meet their functional needs, supporting entrepreneurship, stabilizing property values, building social cohesion, and increasing perceptions of safety. Already, some residents are using vacant land as play areas,

for social events, and for gardens as convenient to them. Other parcels have been maintained as a “cue to care” to signal stewardship and concern. Over the course of several workshops, residents proposed diverse uses and activities for vacant land that, many with even minimal investment, could provide substantial benefits through ephemeral and flexible programming along the E 105- E 93 Street Corridor.

For functional needs, residents proposed cultivating community agriculture on vacant lands in order to meet nutritional deficiencies and the unavailability of fresh produce and healthy, affordable meals along the corridor. Gardens, along with weekly farmers markets, can provide nourishing food while encouraging regular supervision of vacant parcels and facilitating greater social interaction between community members. As safe, accessible community facilities are not available for children, residents proposed the conversion of some of the vacant land into playgrounds and public open spaces, and for larger parcels to be considered for the development of community and recreation centers.

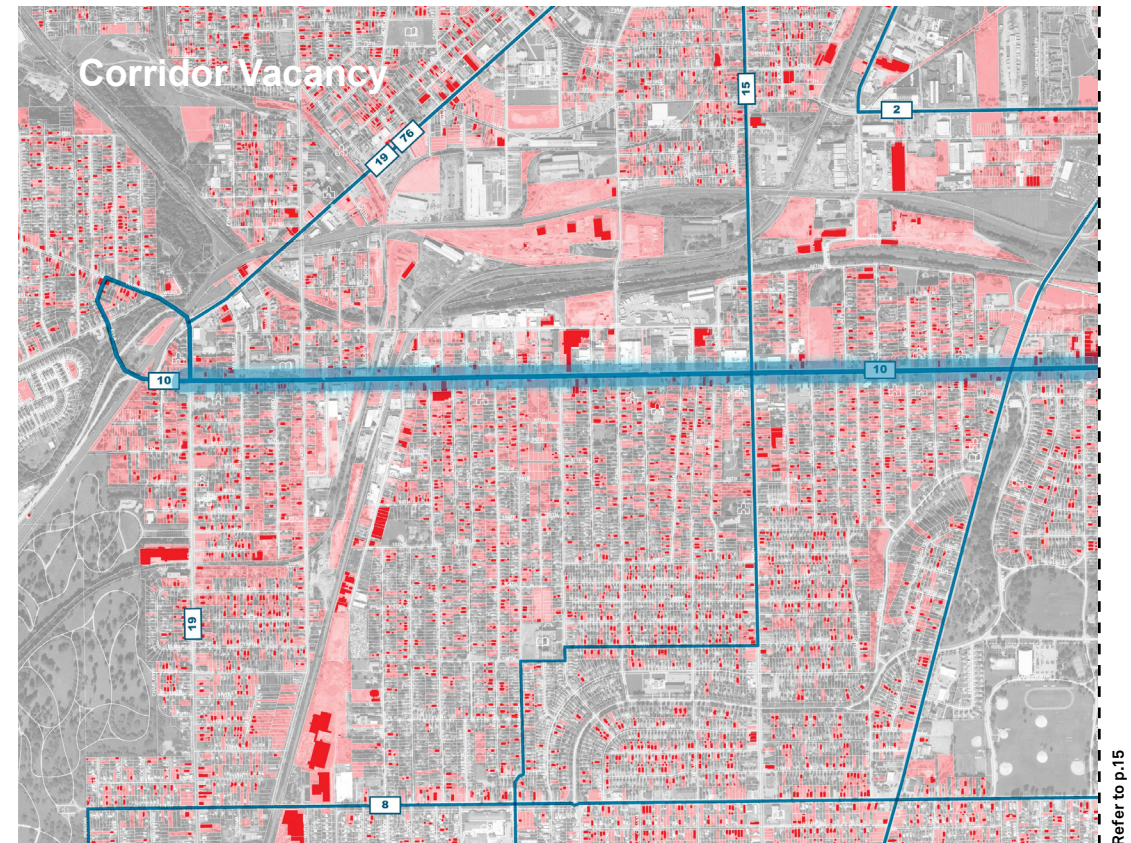

Vacant property can support entrepreneurship by providing affordable leasing and ownership of storefronts, buildings, and land to incubate small-scale creative enterprises and community-oriented ventures in the central Cleveland area. Partnering these spatial assets with local skills development programs, schooling and university curricula, and with programming by local government, community based organizations, religious organizations, and nonprofits can lead to economic growth for resident business owners, workers, and collectives. Additionally, a depository and store for salvaged building materials and home

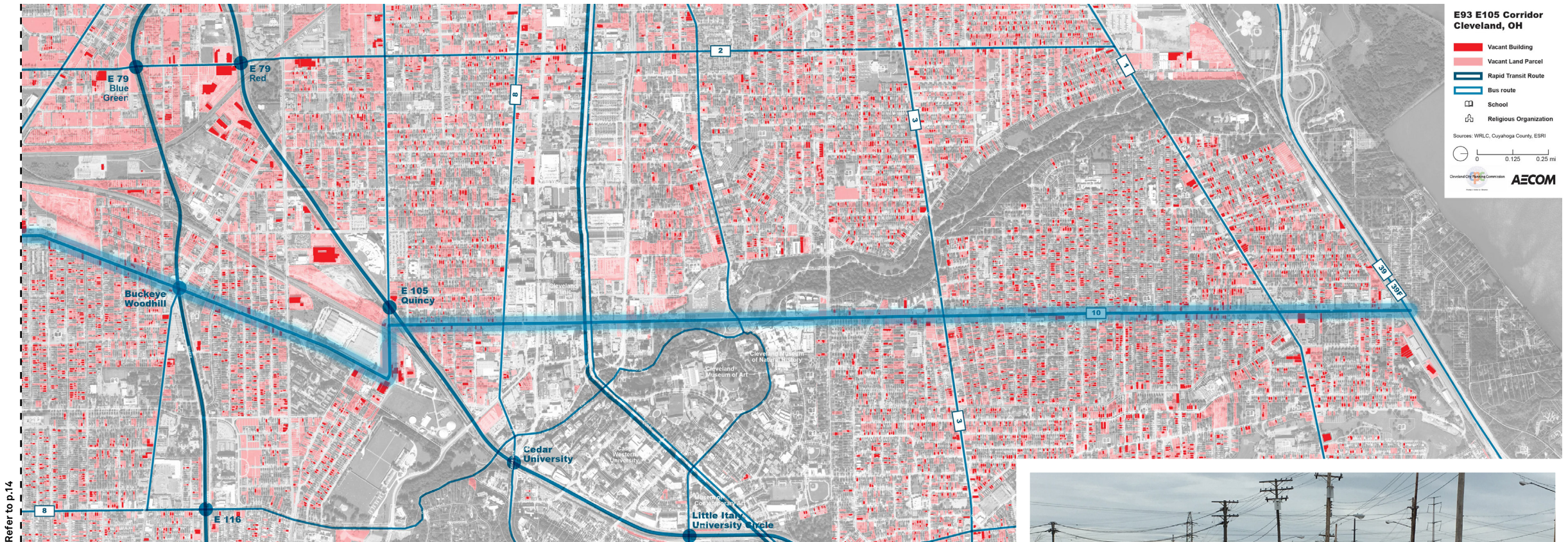

improvement tools could be located along the E 105 – E 93 St corridor to provide residents with affordable means by which to repair, restore, and modernize their dwellings themselves with minimized costs. Over the longer-term, investment in development of vacant land and re-development of vacant buildings and storefronts can expand economic opportunities for residents along the corridor, stabilize property value and increase accessibility to retail, more nourishing grocery stores, community centers, and amenities.

The programming of vacant land can stabilize property values and improve the perception of safety along the E 105 – E 93 St corridor. Residents proposed using vacant property for artists' residencies and studios, art galleries and installations, and neighborhood festivals that link together an archipelago of properties. A holding strategy for property, such as the conversion of vacant property on the corridor into aesthetically-pleasing landscaped parking lots, can increase off-street parking while simultaneously providing corridor-



facing land for use as farmers’ markets, outdoor dining, “pop-up” stores and markets, food trucks, and community events. Such regular activities can increase neighborhood vibrancy, social cohesion, and provide opportunities for creative expression while also generating support for local livelihoods. Mobility and public realm improvements such as improved sidewalks, upgraded bus shelters, wayfinding, and continuous street lighting will also improve perceptions of safety in the corridor’s neighborhoods.

+ Connected Corridor

Route 10 is the primary RTA service operating in the corridor. One of RTA’s highest ridership crosstown routes, Route 10 connects most of the East Side’s radial bus, rail and BRT lines, while providing direct service to the Cleveland Clinic-University Circle area from the northeastern and southeastern areas of Cleveland. The route operates on E. 105th Street from the DuPont Loop (just south of Lakeshore Boulevard) to Quincy, then south on Woodhill and E. 93rd Street to the Turney-Ella Loop near Broadway Avenue. Five trips per day continue west on Harvard Road to ArcelorMittal. Route 10 has been served by a detour route since June 2017 in the area between Euclid and Quincy due to Opportunity Corridor construction.

RTA’s on-time performance goal is 80%. Route 10 performance is similar to the average for all RTA bus routes. Stop spacing on Route 10 averages 7.9 stops per mile, ranging from 5.6 stops per mile in the segment between Superior and Euclid Avenues, to 10.4 in the area between Dupont Loop and Superior. For comparison, stop spacing on the HealthLine is about 4.8 stops per mile. In 2013, Route 10 carried 1,401,084 passengers. It was RTA’s 10th highest

What is the one area that would most improve service on this route?

250 out of 273 people answered this question

1	Buses arriving on time reliably	92 / 37%
2	More benches or shelters at stop	72 / 29%
3	More frequent trips	64 / 26%
4	More weekend service	48 / 19%
5	Extend routes to other areas (input destinations in the "other" field)	31 / 12%
6	Longer hours of service	24 / 10%
7	Other	24 / 10%

ridership route, and 2nd highest ridership crosstown route after Route 41 Warrensville. The heaviest stop activity occurs at the major crossing streets, where the route connects to crossing bus routes, and in the Clinic segment between Chester Ave and Cedar Ave. A number of stops north of Chester and south of Buckeye had no boardings in the 2013 RTA on-board survey. Interestingly, stop activity northbound is more concentrated at Euclid Ave and in the Chester-to-Cedar segment. In the southbound direction, stop activity is more evenly balanced between the Euclid, Buckeye, Kinsman, Union and Broadway stops.

The HealthLine is, by far, the most important source of transfer activity for Route 10. Other major east-west radial bus routes (Routes 1 St. Clair, 14 Kinsman, and 15 Union-Miles, among others) are also important sources of transfers. RTA’s rail transit (Red, Blue and Green) lines are less important as transfer connections.

Bus Route 10 Rider Survey Results

Most of the respondents were using the bus to get to work (49%), school (22%), or to get to a medical appointment

(19%). Most (67%) use the bus to make this trip five or more times a week. Most respondents (68%) walked to the bus, but about half (49%) planned to transfer to another bus route or rail line to complete their trip. Of those connecting with another route, the largest number connect to Route 1 (St. Clair) and the HealthLine. Many also connect to Routes 15 (Union-Harvard), 14 (Kinsman), 11 (Quincy-Buckeye), and 76 (Broadway-Miles). Connections to the Red, Blue and Green lines were surprisingly few.

61% of respondents were satisfied or very satisfied with their bus service and 83% would recommend RTA to family members and friends. When asked how the service could be improved, the largest number (37%) cited on-time operations reliability of the bus service as the most important improvement. The late running of buses is often associated with overcrowding, which the study team observed on a number of Route 10 trips operating during the after school and afternoon peak periods. Other improvements cited include more benches and shelters (29%), more frequent trips (26%) and more weekend service (19%).

Bus Route 10 Transfer Activity

Stop spacing could be increased. Most of the ridership activity happens at the major transfer points at Superior, Euclid, Quincy, Kinsman and Union – potential sites for super-stops, larger shelters and greater amenities, and intersection improvements to support transfers. If capital investments are made in the corridor, service frequency should be improved. Consider terminal anchors for the route, rather than turning the route at the bus loops. The potential exists to connect to shopping centers or other destinations along Broadway or Lakeshore.

The HealthLine is, by far, the most important source of transfer activity for the Route 10 bus. Other major east-west radial bus routes (Routes 1 St. Clair, 14 Kinsman, and 15 Union-Miles, among others) are also important sources of transfers. RTA's rail transit (Red, Blue and Green) lines are less important as transfer connections.

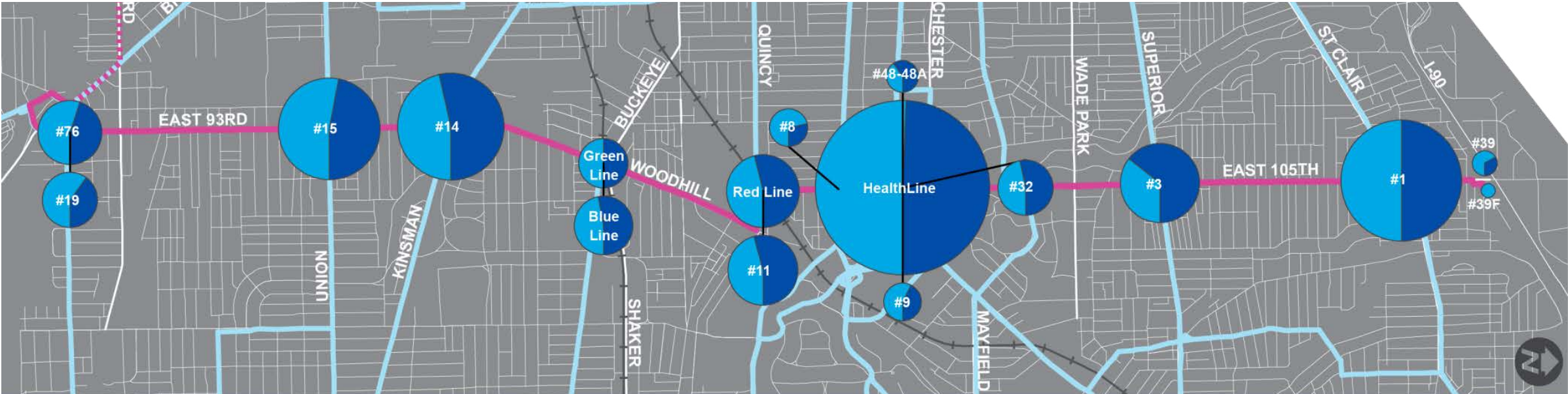

TRANSFERS TO AND FROM ROUTE 10



Currently, no bike facilities exist on the E 105th/E 93rd Street corridor. However, two projects are planned for the corridor south of Quincy Avenue: Woodhill Avenue/E 93rd Street (Quincy Avenue to Kinsman Road) and E 93rd Street (Kinsman Road to Miles Road). Several other projects that cross, start, or end at the corridor are also planned, including projects on St Clair Avenue, Superior Avenue, Quincy Avenue, and at the Opportunity Corridor.

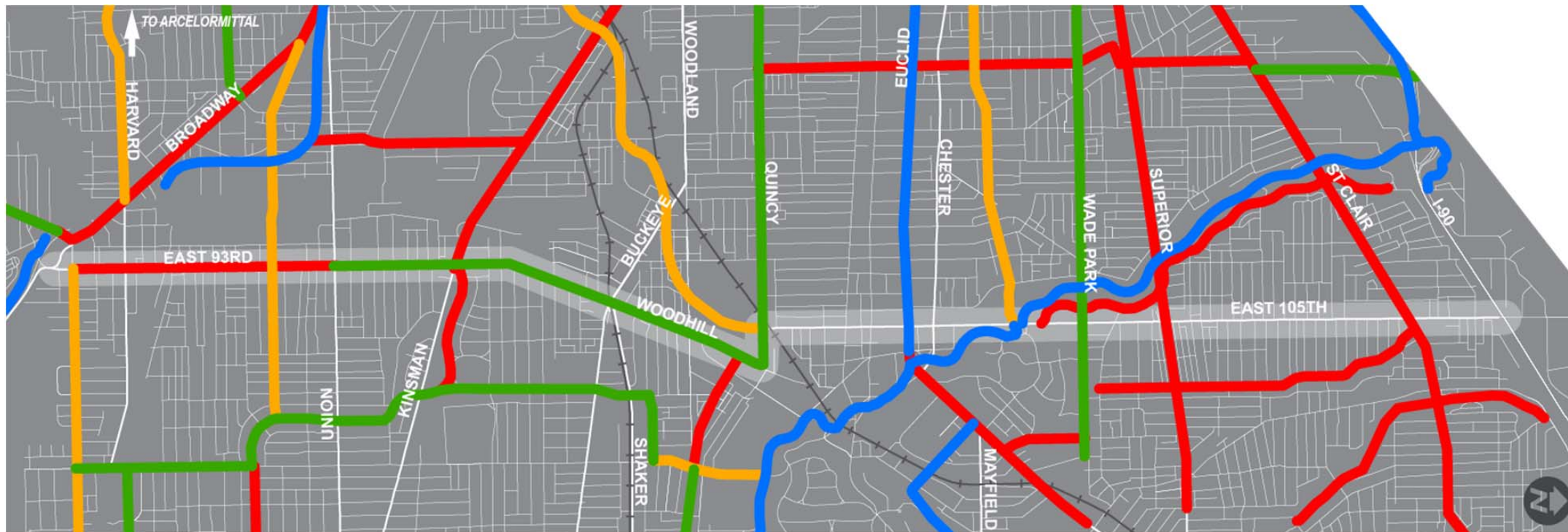

BICYCLE FACILITIES (EXISTING AND PROPOSED) IN STUDY AREA

- EXISTING
- 2016-2017 ADDITIONS
- 2014-2015 ADDITIONS
- NOT IN CAPITAL IMPROVEMENT PLAN

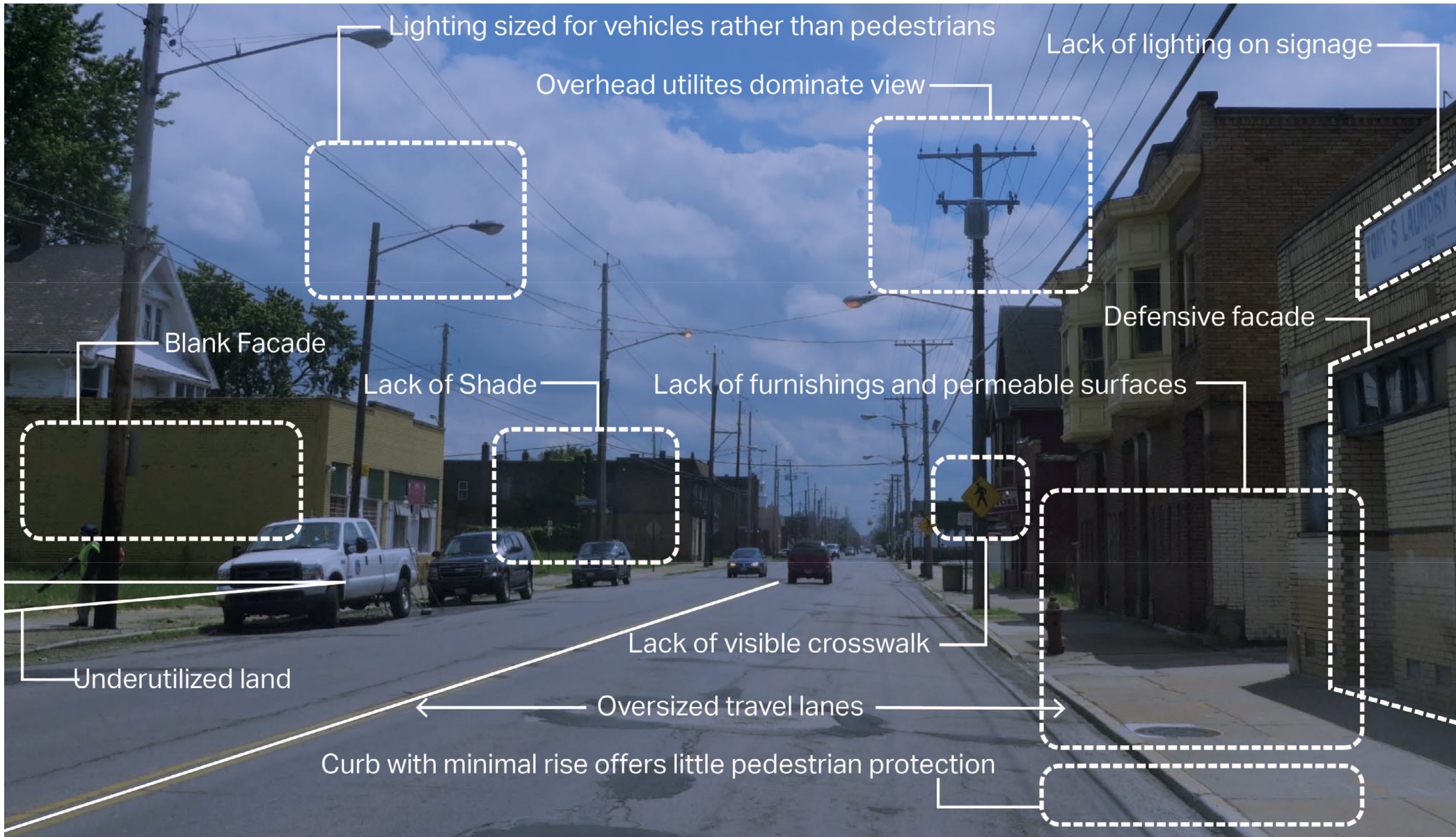

Image depicting public safety and comfort challenges within the current public realm.

Public realm - public relations

The streetscapes currently send mixed messages to residents and potential investors. While some locations new artwork and well maintained parks create a welcoming sense of community, many other locations suggest neglect or fail to create an atmosphere of safety. Many factors contribute to these mixed impressions. The net effect though can deter pedestrian activity, commerce and social interaction. Conversely, the same factors contribute to reduced levels of perceived public safety.

A “Connected Corridor”

The Thrive 105-93 Corridor Framework proposes substantial public realm improvements for safer transit-accessible neighborhoods, and the programming and strategic development of vacant land and buildings to stimulate livelihood growth and greater connectivity between neighborhoods, community services, and amenities. Pedestrian and bicycle networks will better connect neighborhoods along the E 105 – E 93 St corridor to the University Circle, to Mill Creek Falls, the Cleveland Lakefront Nature Preserve, Rockefeller Park, and to smaller publicly-owned open spaces.

Through discussion with the community and City staff, six major neighborhood nodes were identified for their redevelopment potential and their ability to provide new employment, residential choices and community services. These community development nodes are located at key intersections and or areas where underutilized land can be consolidated and repositioned for more future use. Nodes include infill development at E 93rd St and Union Ave, E 93rd St and Kingsman Ave., and at E 105th St and Superior Ave; and transit oriented development at Buckley and Woodhill Rds, Woodhill Estates, and The New Economy neighborhood. In concert with rehabilitation of vacant buildings and storefronts along the corridor, these nodes will support local entrepreneurship and connect the community programming and activity.

In addition to the development nodes, two areas between the freight rail corridor and E 93rd Street offer opportunities for flexible redevelopment for new employment. The first such area is bound between E 93rd St, E 91st St, Cannon Ave, and Aetna Rd. The second is bound E 93rd St, E 87th St, Manor Ave, Holton Ave, and Woodhill Rd. These low-activity areas are composed of numerous vacant parcels, have very low housing occupancy, and can be consolidated into sites greater than five acres in size. In accordance with the existing topography, the sites can be terraced into a series of flat developable areas for light-industrial or other non-residential, employment-generating uses. These locations benefit from access to the regional highway network and existing businesses.

Diagram illustrating the corridor framework of connections and destinations.

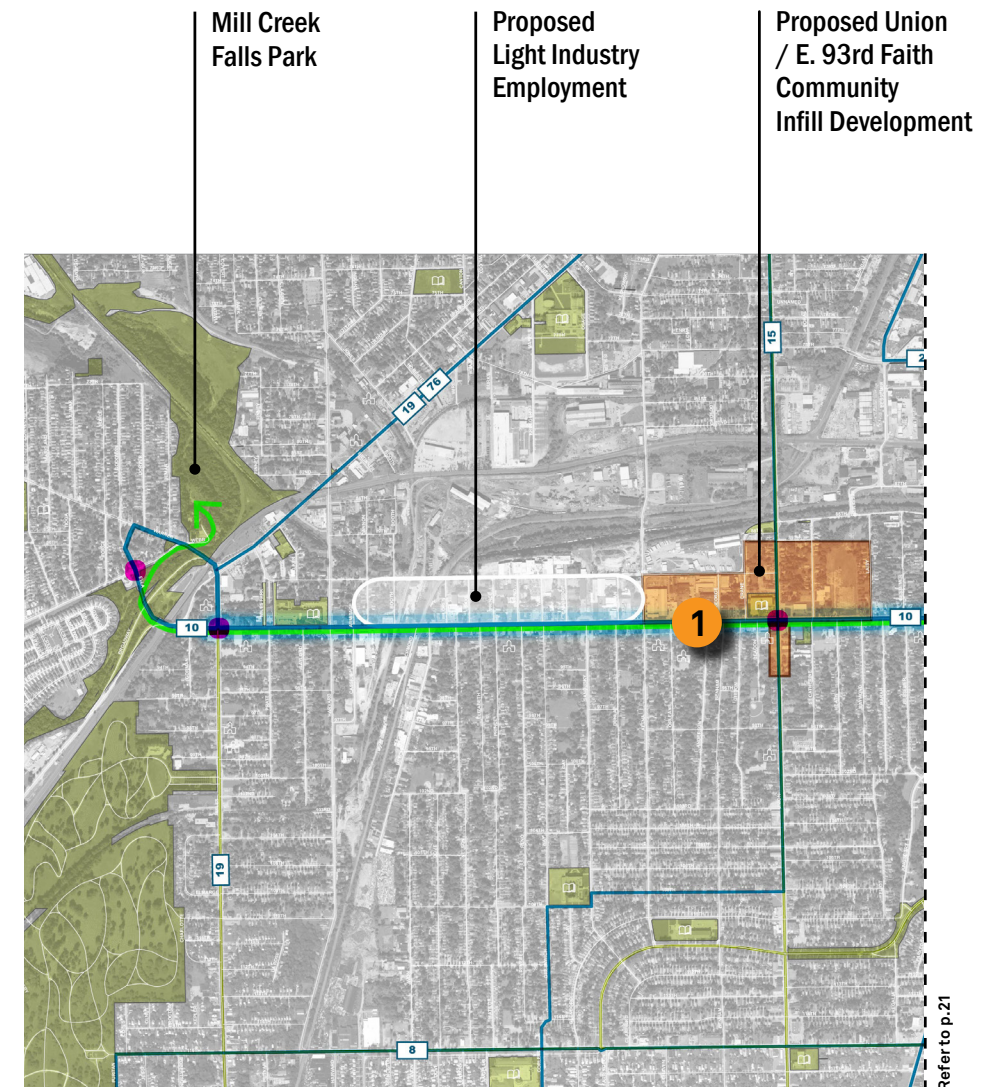

Refer to p. 21



02

COMMUNITY
BUSINESS
MODELS



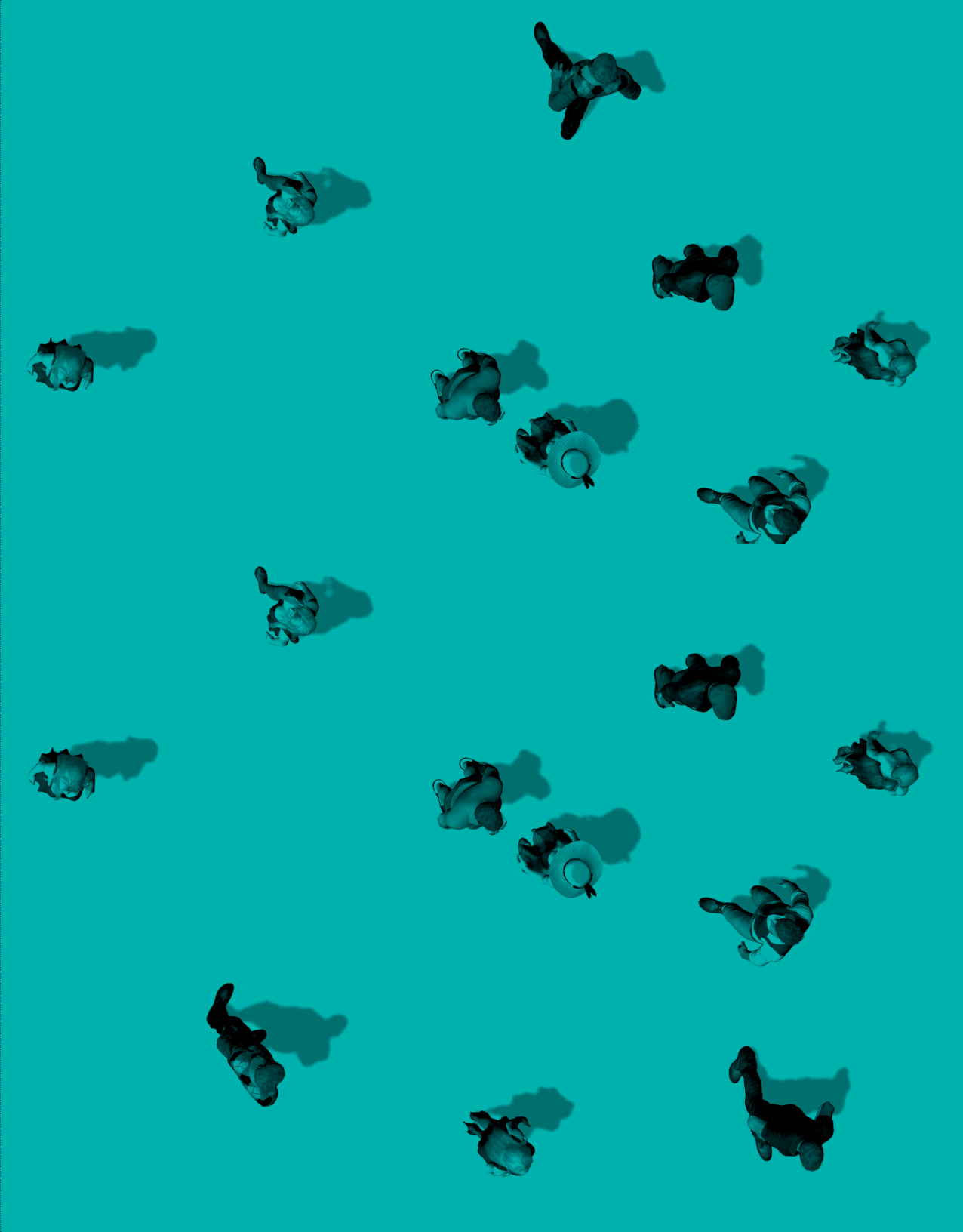

+ The corridor's success will be as much about destinations as it is about connections.

Six specific areas were chosen for a more detailed look into enhancements that can improve quality of life along the entire corridor. In each location, suggested public realm improvements, community and economic development opportunities, urban design principles, and supporting policies and programs for implementation were developed through workshops with the communities and stakeholders. The six areas include the intersection of E 105th Street and Superior Ave, the New Economy neighborhood, Woodhill Estates, the intersection of Buckeye Rd and Woodhill Rd, and the intersections of Kinsman and E 93rd St and Union Street and E 93rd. The following section describes the proposed enhancements and development guidance at each location.

E 105th & Superior Ave

E 105th and Superior Ave will be revitalized as an activity hub within Glenville, driven by multi-generational housing and cultural and recreational amenities.

Targeted Land Uses

Housing will become more accessible through zoning for age-targeted development and assisted living, with residential infill encouraged at lower densities. The neighborhood will serve retail, along with artist-maker spaces with residential components, and cultural facilities tied to the neighborhood’s history and to the adjacent cultural gardens.

Urban design / Street Design Principles

Heritage Lane and the VA Hospital will be better connected to Superior Ave with infill development that activates E 105th Street. New open space will connect E 105th and Rockefeller Park, and the #10 bus transfer experience will be improved along with widened sidewalks at Superior Ave and E 105th Street. Off-street public parking along E 105th will support access to businesses, and a new streetscape along E 105th will include street trees, furnishings, pedestrian lighting, and interactive art. Density will range from Mixed-Use along E 105th to Single Family Residential in adjoining neighborhoods, with buildings addressing the street with appropriate massing to complement context.

Signature Place-Making Concepts / Amenities

Intersection enhancements will include crosswalks, bus shelters, lighting, signage, furnishings, plantings, paving and interpretive art. Gathering space will be created at the northwest corner of Superior and E 105th and the Glenville Park at Churchill and E 105th, and East Blvd. will be enhanced as a pedestrian / bicycle greenway. The cultural gardens, with a new interpretive cultural center, will be expanded along Superior Ave corridor to E 105th. A Rockefeller Park trailhead will also be created at Ashbury and E 105th.

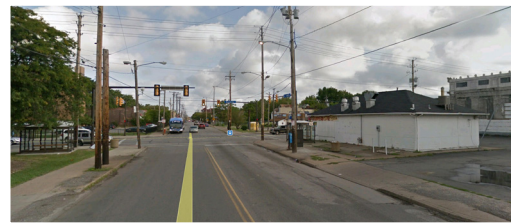

Existing Condition



Artists depiction of 105th looking North to Superior Ave

Priority / Catalytic Actions

The streetscape, including trees, lighting, and furnishings, will be enhanced along with signature bus stops and pedestrian amenities at Superior and E 105th. Property at the northeast and southeast corners of the intersection will be redeveloped, and significant underused structures at the immediate node will be targeted for pilot economic development initiatives. The former Wade Park / Harry E Davis School site will be adapted into residential or institutional spaces. Additionally, public off-street parking lots will be developed, utilities infrastructure will be undergrounded and excess utility infrastructure and bollards will be removed.

Supporting Program and Policies

A strategic relocation strategy will be developed to cluster existing retail businesses in optimal locations, and a storefront renovation assistance program will be initiated to incentivize and fund façade improvements. Form based zoning and / or form based design guidelines will be instituted for the district, and transit oriented development opportunities will be stewarded that capitalize on transit and pedestrian activity.

The "Purpose-Built" model will be explored in broader community to retain and attract residents. Inclusionary Zoning will be incentivized to increase the availability of affordable housing for low and middle income households as a share of new residential construction, and eligibility will be expanded for low to moderate income households by lowering down payments and increasing flexibility through the HomeReady Mortgages program. Affordability of

housing for lower-income homebuyers will be maintained by sharing equity amongst homebuyers through development of Community Land Trusts. A CMHA / Student Housing Integration Strategy will also be developed to provide affordable, diverse, and aesthetically pleasing housing for low income students. An urban agriculture production program will be developed that builds on the success of existing activities throughout the corridor.

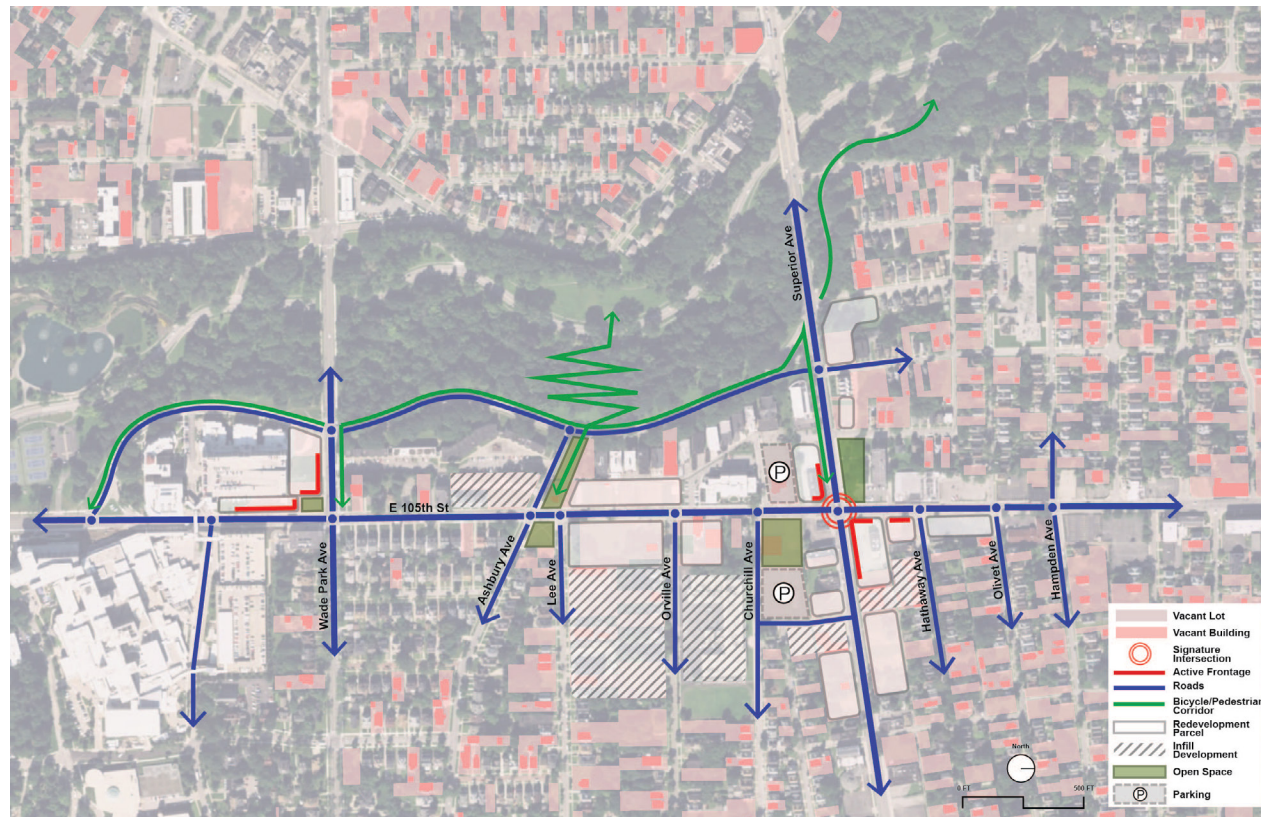

Urban Design Guidance



Illustration of Infill Development Potential

New Economy Neighborhood

The New Economy Neighborhood will become a dense, mixed-use, urban neighborhood destination for regional research and medical technology development.

Targeted Land Uses

Larger-format office and research spaces, regional retail destinations, and a signature expansion of a medical campus will precede mixed-density market-rate residential development in later phases.

Urban Design / Street Design Principles

A connected, walkable urban street grid will be created to utilize the existing right of way to the extent practicable. The grid will include inviting connections across E 105th to the Fairfax Innovation Square redevelopment. A mix of building types and footprints, with a variety of building heights and massing along E 105th, will be supported with active building façades, front doors oriented towards the street and key corners, and parking shielded at the center of each block.

Signature Place-Making Concepts / Amenities

A central park space will be established that connects to Fairfax Innovation Square and manages storm water for the collective redevelopment area with additional plaza spaces at key E 105th crossings at Carnegie, Cedar, Frank and Hudson. The E 105th Opportunity Corridor landscape will be enhanced with seating areas, street trees and activated ground floors. Thematic, interactive lighting installations that illuminate facades along E 105th will be incorporated, as will experiential art installations that interpret medicine, individual health and neighborhood health.

Priority / Catalytic Actions

Property will be strategically aggregated to facilitate efficient redevelopment, and a strategy will be prepared for coordinated strategic demolition, site stabilization and marketing to prospective developers. A site-wide infrastructure plan will be developed to determine investments needed to position properties. The Quincy and E 105th Rapid Station plaza will be coordinated with Opportunity Corridor design build effort. Bus stop enhancements will also be coordinated along the E 105th segment of the Opportunity Corridor.



Existing Condition



Artists depiction of Cedar & E 105th looking South

Supporting Programs and Policies

Form-based zoning and / or form-based design guidelines will be instituted for the district, and a master developer strategy will be determined to execute comprehensive redevelopment over time. Positive social and economic change will be encouraged in disadvantaged communities with Innovation in Social Entrepreneurship to use new and creative practices to address unemployment,

underemployment, post-incarceration employment, educational disparities, as well as other issues. A program will be initiated to host urban health themed events on future development sites. In addition, transportation savings will be made available to middle-income homebuyers so they can qualify for Smart Commute Mortgages in transit-rich areas.

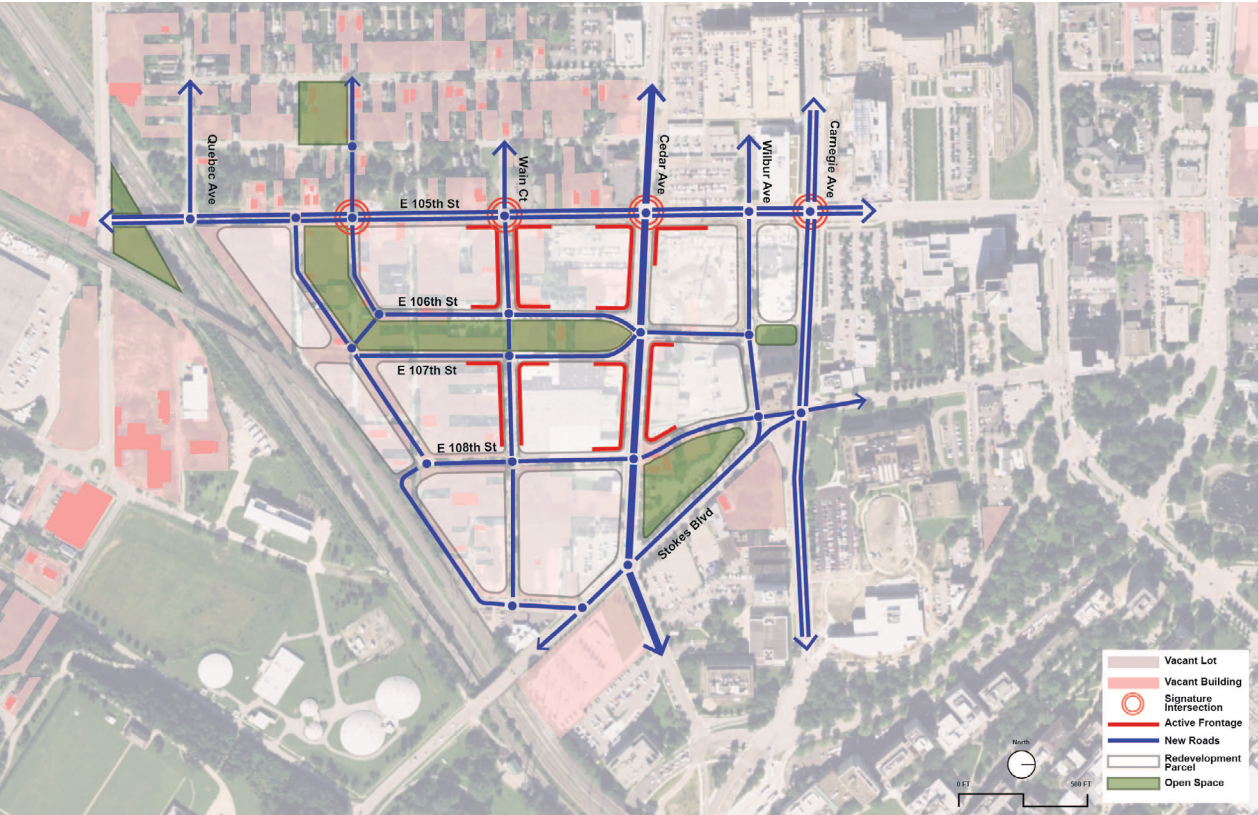

Urban Design Guidance



Illustration of Infill Development Potential

Woodhill Estates

Woodhill Estates will be revitalized as a transit-oriented, mixed-income community.

Targeted Land Uses

Mixed-income market rate housing, affordable housing, infill residential, and retail uses will be targeted in existing neighborhoods. Mixed – use transit oriented development will be encouraged along Quincy to connect with the Rapid stop. Grocery stores, job training, and community services / facilities will be prioritized.

Urban Design / Street Design Principles

The street grid will be extended and connected throughout the surrounding community in order to improve access, with the community oriented outwards to adjacent major streets by placing front doors on Woodhill Rd and Woodland Ave and with new pedestrian and bicycle connections established to Stokes Blvd. Infill development will be encouraged on vacant lots within the existing community, and the barracks-like public housing will be redeveloped into new affordable residential products. More animated experiences will be established along Quincy to the Rapid station along with a new job training center.

Signature Place-Making Concepts / Amenities

The existing community center will be surrounded with a new park that connects from Woodhill and Woodland to Stokes Boulevard. The RTA service yard wall will be animated with lighted murals completed by residents and local artists that depict the Cleveland skyline in

different, unique ways. The railroad bridge over Quincy will also be animated through interactive art installations. A destination playground will be established within the new park connecting the residential and theme park histories of the site, and a linear park will be developed along Woodstock Ave that connects to MLK Jr. Ave. The plaza will be expanded with an iconic gateway element to access Rapid Station at Quincy and E 105th.

Priority / Catalytic Actions

The Woodhill streetscape will be improved for public safety, accessibility, and character, including the RTA wall. Investments along Woodhill will enhance bus stops, including crosswalks, bus shelters, lighting, signage, furnishings, plantings, paving, and interpretive art.

Supporting Programs and Policies

A housing transition plan will be developed to manage evolution to new housing opportunities. Pedestrian / bike

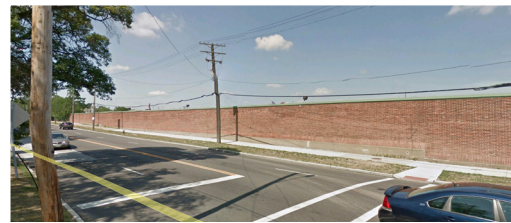

Existing Condition



Artists depiction of Woodhill Rd & Mt. Carmel

connections will negotiate Baldwin to extend to Stokes Blvd. Positive social and economic change will be encouraged in disadvantaged communities with Innovation in Social Entrepreneurship to use new and creative practices to address unemployment, underemployment, post-incarceration employment, educational disparities, as well as other issues. A job training center and mixed-use development will be planned along the Quincy segment connecting Fairfax / New Economy with Woodhill Estates.

Community Benefits Agreements will be used to hold developers accountable in delivering specific benefits outcomes to communities they affect with new development. The physical design of CMHA projects will be aligned to promote mixed-income communities and integrate CHMA and low-income residents within high market value areas using the CMHA / City of Cleveland Integrated Physical Design.



Artists depiction of RTA stop on Quincy Ave

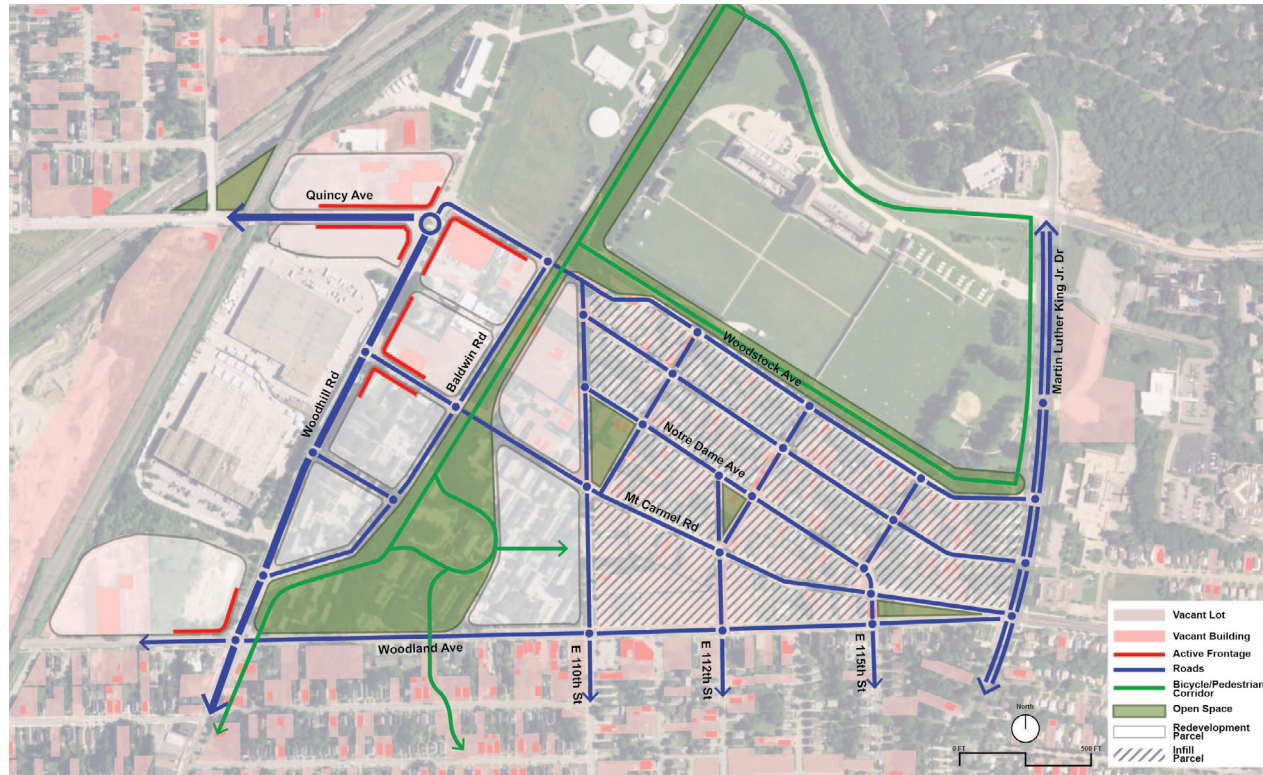

Urban Design Guidance



Illustration of Infill Development Potential

Buckeye & Woodhill Road

Buckeye and Woodhill Road will become a transit-oriented neighborhood hub accessible to light industry.

Targeted Land Uses

Mixed-use infill development will be created at the Rapid Transit station. New retail and new open spaces will be created that will serve the existing neighborhood and local community.

Urban Design / Street Design Principles

New developments will be created with activated ground floors that face the intersection and are oriented towards the street. Vacant land will be consolidated for larger scale development opportunities. Sites north of Holton Street will be developed for residential Transit Oriented Development. A cycle track will be created along the eastern edge of Woodhill Road.

Signature Place-Making Concepts/Amenities

Intersection enhancements including crosswalks, pedestrian lighting, street trees, integrated art and signature bus stops will be created at intersections on Woodhill Road and Buckeye Road. A unique architectural design element at each “point” will be incorporated that relates to other “points” across intersections. A linear park, following the Rapid Line, will be created that connects new residential development to the existing station. Churches will be incorporated as place-making elements in new developments.

Priority / Catalytic Actions

A coordinated strategy of demolition, site stabilization and marketing strategy will be prepared for prospective developers. Public realm improvements at intersections will be created to compliment recent roadway improvements. Streetscape enhancements, including trees, lighting, furnishings, etc., will be implemented. Bus stop enhancements at intersections including shelters, lighting, signage, furnishings, plantings, paving and interpretive art will be implemented.



Existing Condition

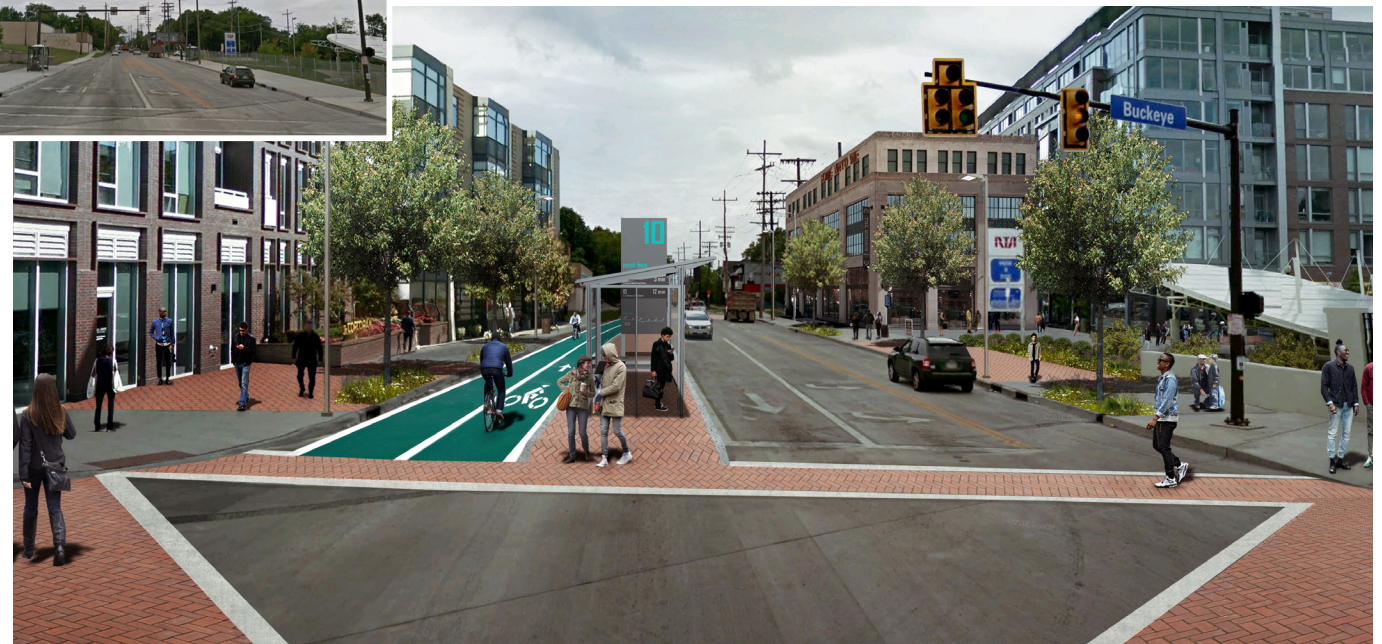

Artists depiction of Woodhill Rd & Buckeye Rd

Supporting Programs and Policies

A coordinated strategy of demolition, site stabilization, marketing strategy and property assembly will be prepared for prospective developers. Community Benefits Agreements will be used to hold developers accountable in delivering specific benefits outcomes to the communities that are affected with new development. Residential development will be catalyzed through public servant

priority incentives for police, fire, public works, teachers, etc. By developing Community Land Trusts, the affordability of housing for lower-income homebuyers will be maintained by sharing equity amongst homebuyers. Transportation savings will be credited to middle-income homebuyers so they can qualify for Smart Commute Mortgages in transit-rich areas. Lower-income homebuyers who qualify for mortgages in transit-rich areas due to transportation

savings using Location-Efficient Mortgages will be helped. Positive social and economic change will be encouraged in disadvantaged communities with innovation in social entrepreneurship to use new and creative practices to address unemployment, underemployment, post-incarceration employment, educational disparities, as well as other issues.

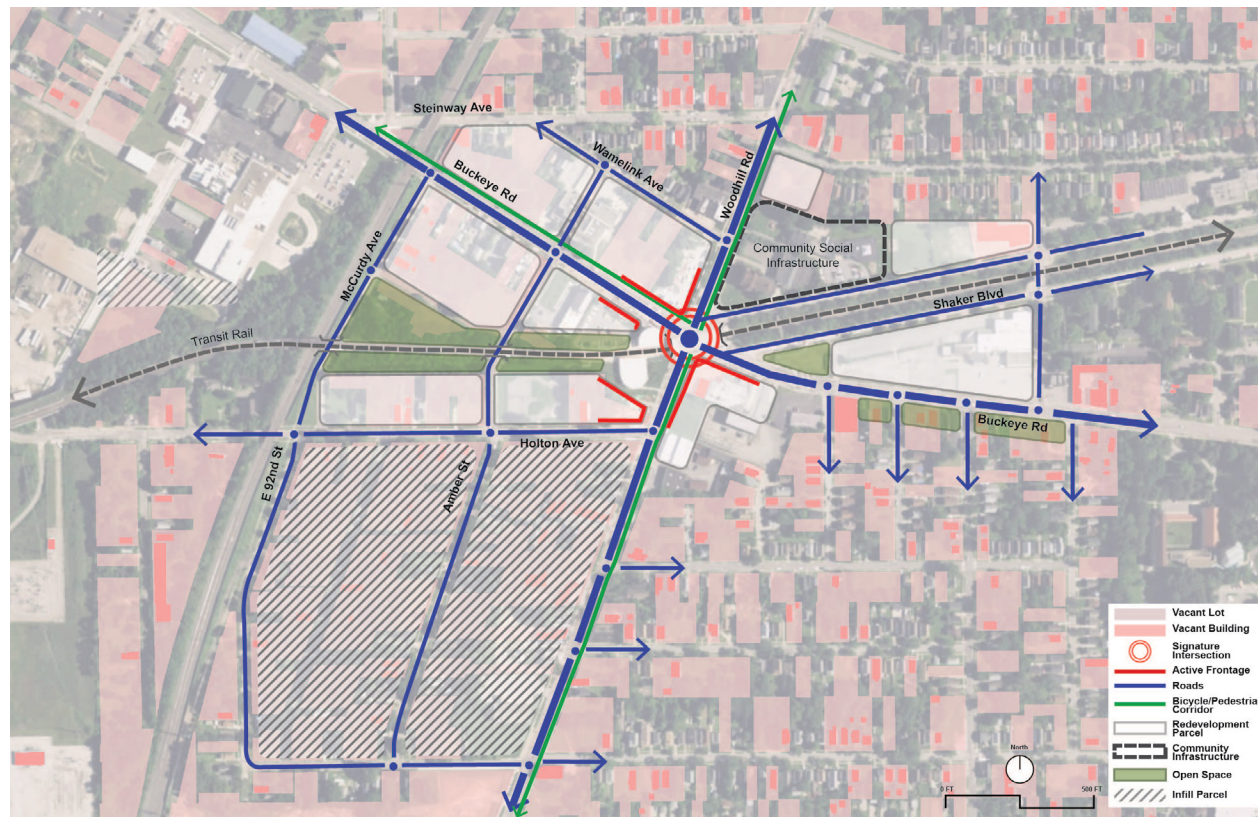

Urban Design Guidance



Illustration of Infill Development Potential

Kinsman – Union & 93rd Street

Kinsman – Union and 93rd Street will become connect clusters of community social infrastructure and employment.

Targeted Land Uses

New neighborhood focused retail and infill residential developments will serve Kinsman Street and Union Street. Clusters for social commerce such as banks, civic uses, etc., as well as park and recreational developments will also be created.

Urban design / Street Design Principles

Neighborhood retail and community services that are within walkable distances will be clustered around Kinsman Street, Union Street, and Harvard Street. Existing large scale vacant property from Buckeye Street to Kinsman Street (West of Woodhill / E 93rd) will be aggregated for light industry (5 acres + viable parcels). A cycle track along the eastern edge of 93rd Street will be created to link with existing Citywide East-West connections. A unified streetscape will create continuity and a sense of place.

Signature Place-Making Concepts / Amenities

Intersection enhancements including crosswalks, bus shelters, lighting, signage, furnishings, plantings, paving, and interpretive art will be created at intersections on Kinsman Street, Union Street, and Harvard Street. The frontage of the Beacon Avenue Park south of Union

Street will be opened to improve visibility, public safety, and recreational opportunities. A cycle track and planted median running the length of 93rd Street will be implemented.

Priority / Catalytic Actions

Safety and aesthetic enhancements including crosswalks, bus shelters, lighting, signage, furnishings, plantings, paving and interpretive art will be created at intersections on Kinsman Street, Union Street, and Harvard Street. Streetscape enhancements such as trees, lighting, furnishings, etc. will be implemented. Bus stop enhancements will be prioritized along the length of 93rd Street.

Supporting Program and Policies

A strategic property strategy will be developed to assemble land for light industry, and a storefront renovation assistance program will be initiated to incentivize and fund façade improvements. An existing school site at Union Street will be utilized to incubate activity through interim use, and small business incubators will be established with access to childcare. A coordinated strategy of demolition, site stabilization and marketing strategy will be prepared for prospective developers. Positive social and economic change will be encouraged in disadvantaged communities with innovation in social entrepreneurship to use new and creative practices to address unemployment, underemployment, post-incarceration employment, educational disparities, as well as other issues. By developing Community Land Trusts, the affordability of housing for lower-income homebuyers will be maintained by sharing equity amongst homebuyers.



Illustration of Infill Development Potential

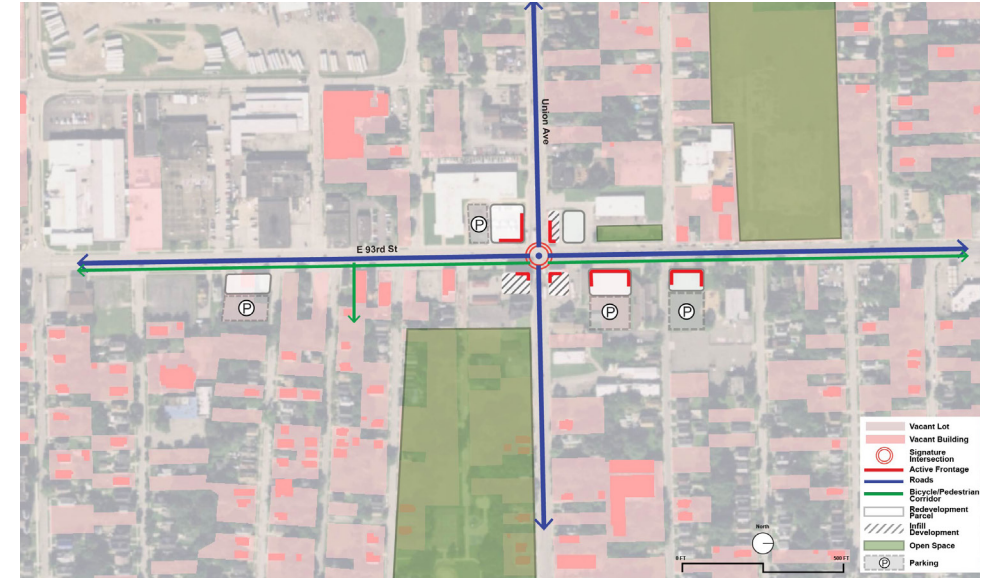

Illustration of Infill Development Potential

Existing Condition



Artists depiction of E 93rd St looking South to Union Ave



Urban Design Guidance

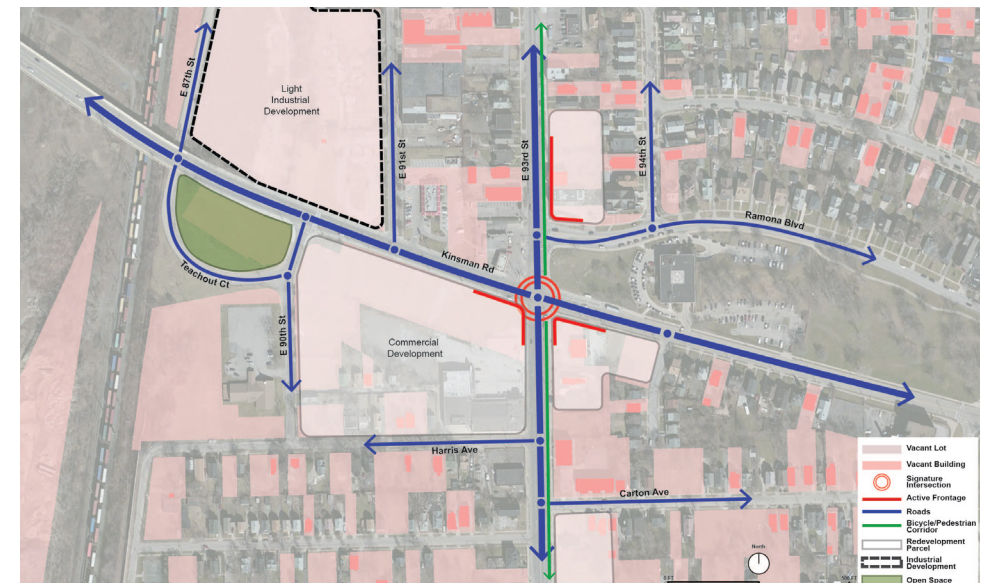

Urban Design Guidance

03

DESIGN
GUIDELINES





+ The corridor will not be uniform. There will be unifying elements, but the design of E. 105th - E. 93rd streets will adapt to the opportunity and amplify the story of each neighborhood.

The street design is shaped by the desire to achieve improved health, equity and sustainability throughout corridor neighborhoods without widening the existing right-of-way. The proposed design concepts addresses improved pedestrian spaces for circulation and gathering as well as significant improvements to the #10 stops, transfers and waiting areas. Bicycle facilities are provided to better connect destinations and improve alternative mobility throughout Cleveland's east-side. Public art concepts have also been developed that celebrate the residents, past and present, that drive the momentum forward.

+ Designing the #10

Route 10 Profile / Existing Condition

Route 10 is the major GCRTA route serving the E 105th – E 93rd corridor, between Dupont Loop in the north and Turney Loop in the south, with five trips serving ArcelorMittal Loop after Turney Loop every day, connecting most of the East Side’s radial bus, rail, and BRT lines. With an annual ridership of 1,401,084 in 2013, it is the 10th highest ridership route in the GCRTA system and 2nd highest crosstown (non-downtown oriented) route. Route 10 operates 24 hours a day, 7 days a week, with 15 minute average headway (between 8 and 17 minutes) during peak hours and midday, 30 minute average headway (between 24 and 32 minutes) during off-peak and weekends, and 60 minute headway during evenings.

Route 10 suffers from on-time performance issues. GCRTA’s 2015 data shows a year-round average on time rate of 69%, with 10% of the service running early and 21% running late (on time is defined by GCRTA as from zero minutes early to five minutes late). Although this is better than GCRTA’s average bus services, which only has 66% of the service running on time, it is more than 10% lower than GCRTA’s 80% on-time performance goal. The 2015 on-time rate suffered significant drops in May, August, September, and October, with the lowest at 62% during August and September, when almost 1/3 (30% in August, 29% in September) of the buses were running late or early. The on-time performance rate started to climb up after October, reached 71% in November and its highest - 78% in December.

Stop spacing on route 10 is relatively dense, at an average of 7.8 stops per mile, compared to the 4.8 stops per mile on the HealthLine BRT and 4.3 stops per mile on the Cleveland State Line (route 55). However, most ridership activity occurs at the major crossing streets, where passengers transfer from radial east west routes that connect to downtown Cleveland. Ridership activity is highest at Euclid Avenue, where the passengers transfer with the HealthLine, but is also high at Quincy Avenue and Buckeye-Woodhill, where passengers transfer to the Red and Blue-Green rail lines; and at St. Clair, Superior and Hough Avenues and Kinsman Road, where passengers transfer to major east-west local bus routes connecting to downtown Cleveland.

Based on analyses and surveys, several aspects of the route 10 suggest the need for improvement:

- + Crowding during the morning and evening peak and after school periods
- + Late running, particularly during rush hour and school periods
- + The need for more benches, shelters and other passenger amenities, particularly at transfer points with the HealthLine, Red and Blue-Green rail lines, and major east-west bus routes.
- + Higher frequency to accommodate existing loads and promote further ridership
- + More weekend service for the convenience of the customer base

#10 On Time Performance 2015

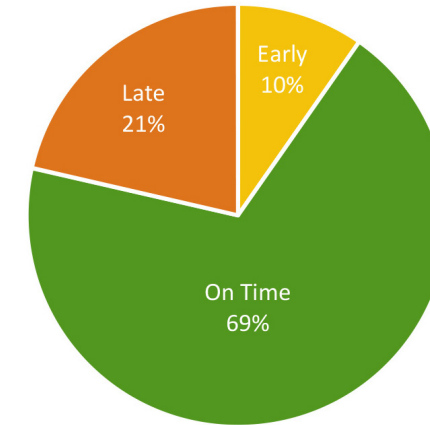

Route 10 On-Time Performance - 2015 Average

On Time #10 vs All Bus 2015

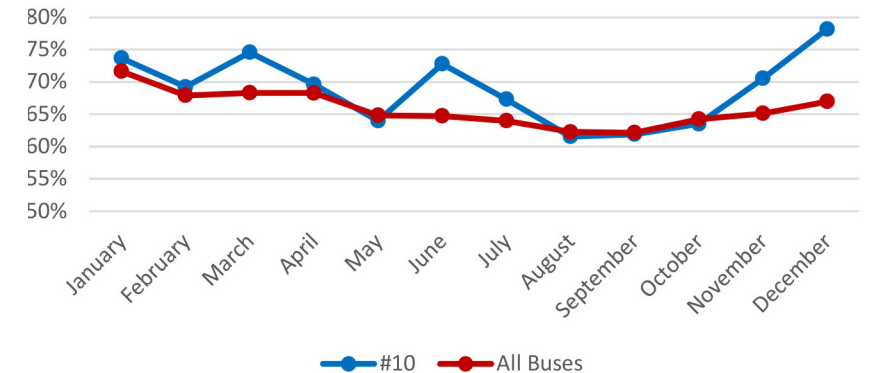

Route 10 vs. All GCRTA Bus Services On-Time Performance

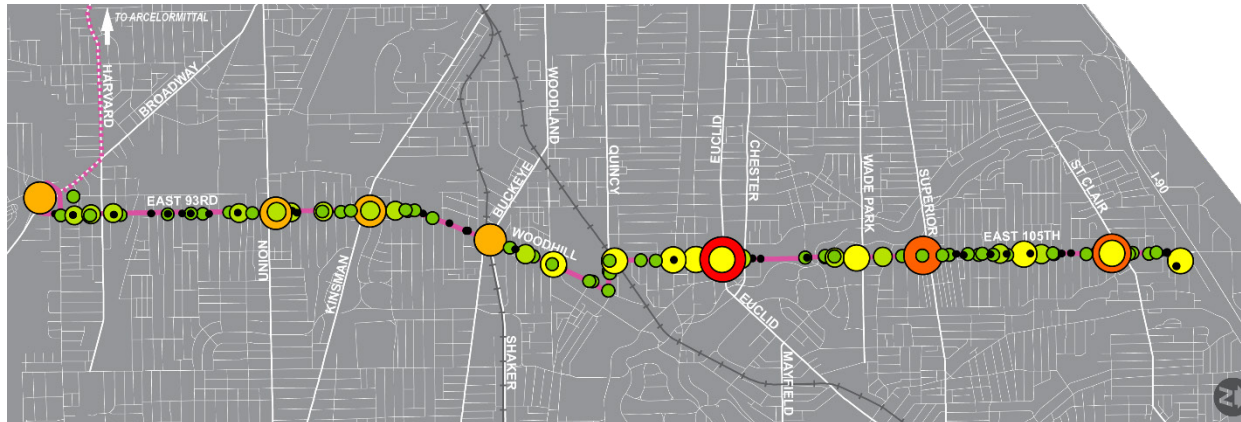

WEEKDAY AVERAGE DAILY STOP ACTIVITY (BOARDINGS + ALIGHTINGS) - NORTHBOUND



WEEKDAY AVERAGE DAILY STOP ACTIVITY (BOARDINGS + ALIGHTINGS) - SOUTHBOUND



Proposed Improvements

The main goal of the following improvements is to increase service capacity, reliability, and to improve rider experience. Such improvements will increase transit use in the corridor, and also will serve as an economic driver and attract investment in the corridor, which will enhance the overall prosperity of the neighborhoods along the route 10 corridor. Converting route 10 to bus rapid transit (BRT) is one of the most effective and efficient ways to achieve this goal. Improvements that will be proposed in the following paragraphs are grouped into two major categories:

1. Service improvement, which includes potential remedies for scheduling, stop locations, and service frequency; and
2. Infrastructure improvement, which includes dedicated lanes, signal priority, bus stop design, amenity upgrades, and stop access improvements.

Service Improvements

Reducing headways on route 10 to 10 minutes during peak hours would help address the problem of overcrowding on the route, which would in turn help to improve schedule reliability. The higher frequency also will help attract additional ridership to the route and make more intensive use of proposed capital improvements. Achieving 10 minute headways during peak periods also is a prerequisite for seeking FTA New Starts or Small Starts program funding, which may be an option for funding improvements in this corridor.

Additional improvements include adding running time to some segments, installing transit signal priority and queue jump lanes at intersections, and integrating bus-only lane restrictions during peak hours in some corridor segments. These improvements, taken together, would improve the schedule reliability of bus services operating on the corridor.

Another improvement that will significantly improve the speed and reliability of the service is to consolidate / eliminate some of the less-utilized stops in order to achieve a wider stop spacing more typical of BRT service. As noted above, RTA's HealthLine and Cleveland State Line BRTs have established a stop spacing range of 1/4 to 1/3 mile, as compared to the nearly 8 stops per mile typical along the E. 105th – E. 93rd Street corridor. In the HealthLine and Cleveland State Line corridors, similar consolidations have resulted in improved travel speed, service reliability, and increased ridership, in part because the reduced number of stops allows for a higher level of amenities, including shelters, benches and lighting, at the stops that remain.

The proposed consolidated stop locations were selected based on the following factors:

- + Major transfer locations
- + Intersections with GCRTA rail lines and east-west bus routes
- + Stop activity (2013 system-wide on-board survey and 2016 on-board survey of Route 10)
- + Proximity to major activity centers
- + Maintaining a level of stop spacing consistent with nearby development
- + Programmed TWE improvements being developed through the Opportunity Corridor project

The proposed stop consolidation is discussed in four sections later in the document: Dupont Loop – Superior, Superior – Cedar, Cedar – Kinsman, and the Kinsman – Turney Loop.

Dupont Loop – Superior

With roughly half of all stops proposed for elimination, the average number of stops per mile drops from 10.3 stops to 4.5 stops, and the stop spacing double from 515 feet to 1,172 feet.

Superior – Cedar

Proposed stop consolidation is least severe in this section, largely due to the retention of all stops that are programmed for TWE improvements with Opportunity Corridor funding (at Chester, Euclid, Carnegie and Cedar stops). Only two pairs of stops are proposed to be eliminated in this section. The number of stops per mile goes down from 5.8 stops to 4.5 stops, with stop spacing increasing from 919 feet to 1,167 feet.

Cedar – Kinsman

Proposed stop consolidation is most severe in this section, where there are few activity centers and most ridership activity is concentrated at a few transfer locations (E 105th & Quincy Ave, Woodhill & Buckeye Rd, Woodhill & Kinsman Rd). The number of stops per mile goes down from 8.1 stops to 2.8 stops, with stop spacing increasing from 653 feet to 1,903 feet.

Kinsman – Turney Loop

This section would experience similar levels of stop consolidation with roughly half of all stops proposed for elimination as Dupont Loop-Superior section. The number of stops per mile goes down from 7.2 stops to 3.4 stops, with stop spacing increasing from 742 feet to 1,568 feet.

Infrastructure Improvement

The bus stop is the most important interface between the bus transit service and the rider besides the bus itself. Its design and the quality of the space can greatly influence riders' experiences, can attract potential transit riders, or drive them away. Since most of the bus stops in the corridor now consist of nothing more than a sign attached to a post or utility pole, with only a handful of shelters on the intersections with major crossroads, one big part of this transit improvement plan is to lift the infrastructure of the consolidated stops to the level of a BRT station that provides a higher level of passenger safety and comfort, as well as reinforcing the brand identity of the BRT service and serving as a community asset that will encourage investment and economic activity. The proposed bus station upgrades were categorized into three tiers based on the level of ridership and space constraint. All three tiers will share the basic amenities:

- + wayfinding totem with real time bus info
- + shelter with bench
- + special paved shelter pad
- + solar lighting and USB charging station
- + supplemental lighting
- + emergency call station
- + bike rack
- + trash receptacle

Bus Stop Locations

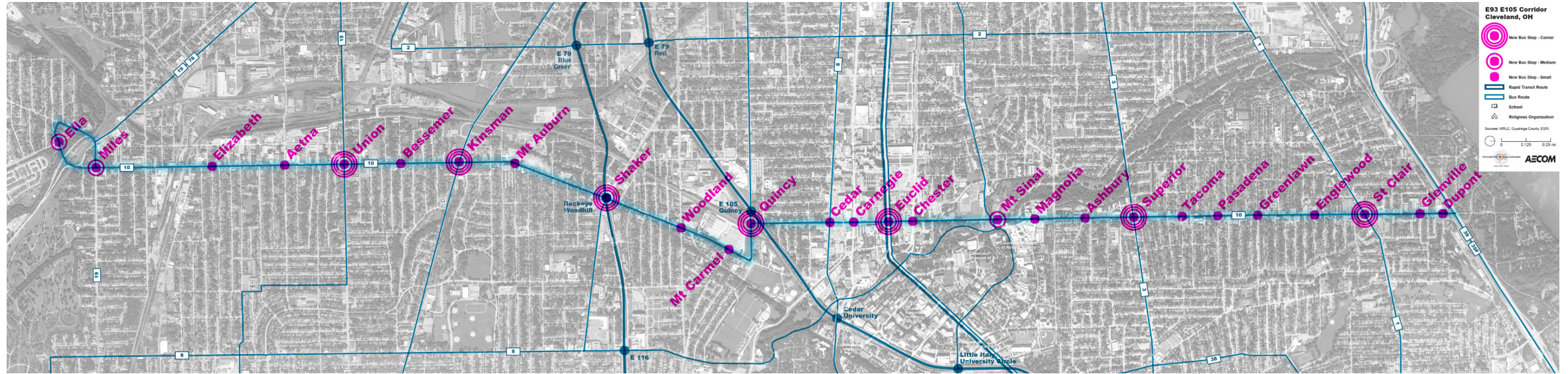

Though there will be differences in size and number of the amenities in each particular stop, the list is considered the checklist for amenities to be included at each stop for this corridor. Green infrastructure will also be universal across all the proposed BRT stops as they not only improve the visual appearance but also aid in storm water management and micro-atmosphere improvement.

The highest tier of proposed BRT station is the **Corner Station**. It is designed with ease of transfer in mind and will be proposed at major intersections with heavy transfer activity. It features the largest shelter and is positioned on the same side of the transfer stops so transfer activity

doesn't require crossing major roads. Scrambled and specially paved crosswalks are also proposed to ease transfer activities that require crossing. Corner parks are proposed if space permits it in order to enhance the transfer experience and strengthen the connection between route 10 stops and transfer services.

The second tier of proposed BRT station is the **Medium Station**. It features mostly the same amenity as the Corner Station but with a smaller shelter. Due to space constraints, only a few intersections could to install this kind of stop.

Diagram depicting the proposed location of and typology of consolidated bus stops.

The third tier of proposed BRT station is the **Narrow Station**. It features the smallest shelter among all three tiers but makes little or no compromise on other amenities. Unlike the other two tiers, which leave space behind the shelter for through pedestrian traffic, the Narrow Station tends to use the entire width of the sidewalk, with the shelter sitting on the edge right next to the lawn. Bike racks are also rotated 90° to save space. These create a compact footprint allows it to be installed at the rest of the stop locations along the corridor.

One of the most notable upgrades of all would be the new wayfinding totem. On the side facing the shelter, the totem features a lit portion on the top for easy recognition even at a distance, a lit route 10 sign with distinct color for each neighborhood for quick locating, a neighborhood map with nearby amenities listed and a route map with stop schedule for fast trip planning, and finally, real time bus information. On the other side it features the RTA logo and a panel that can mitigate costs through advertising.

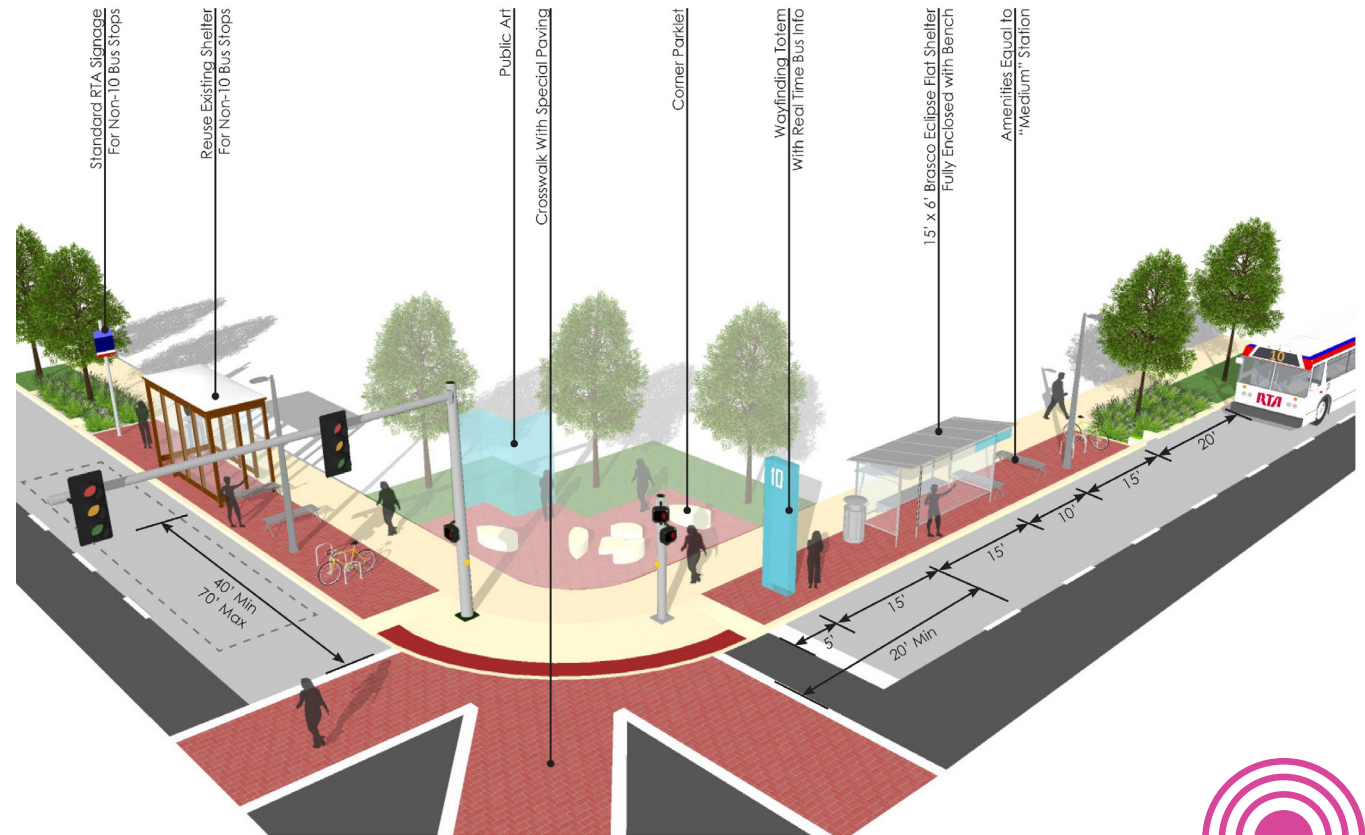

Corner Station



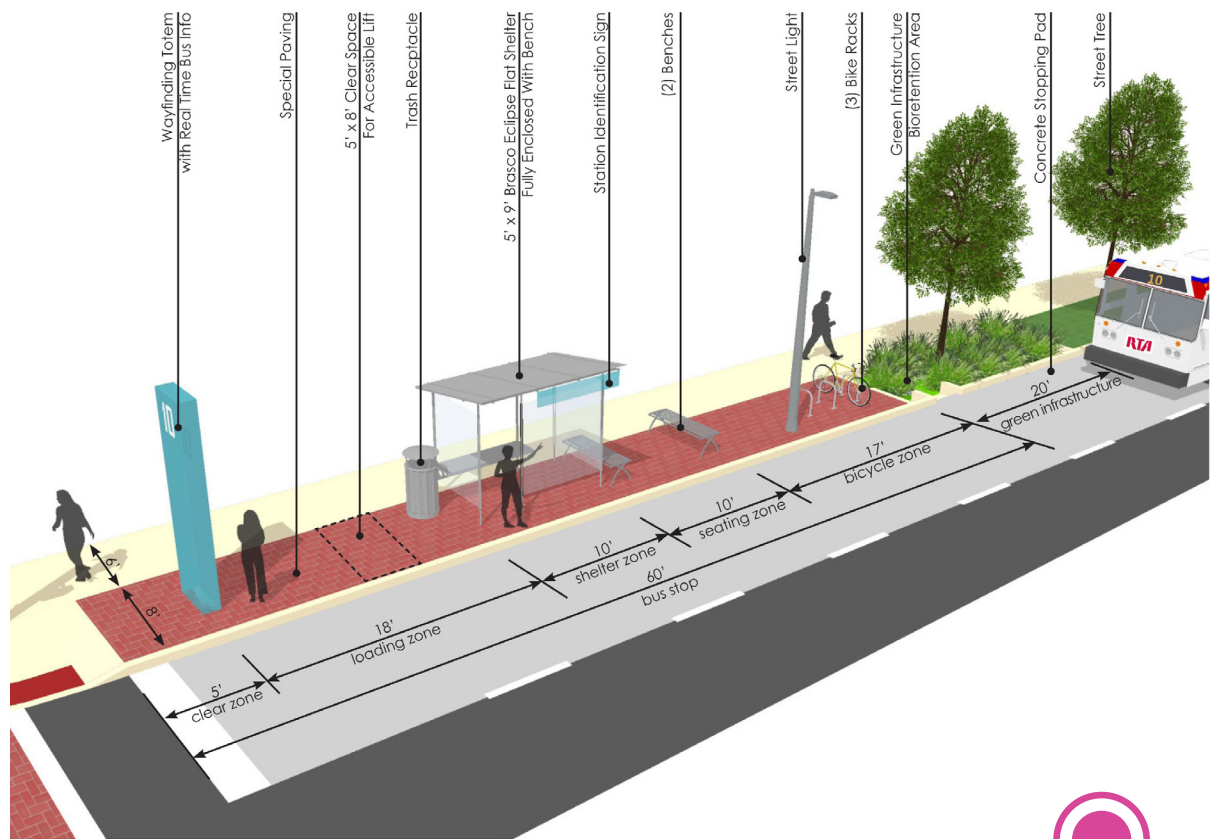

Medium Station

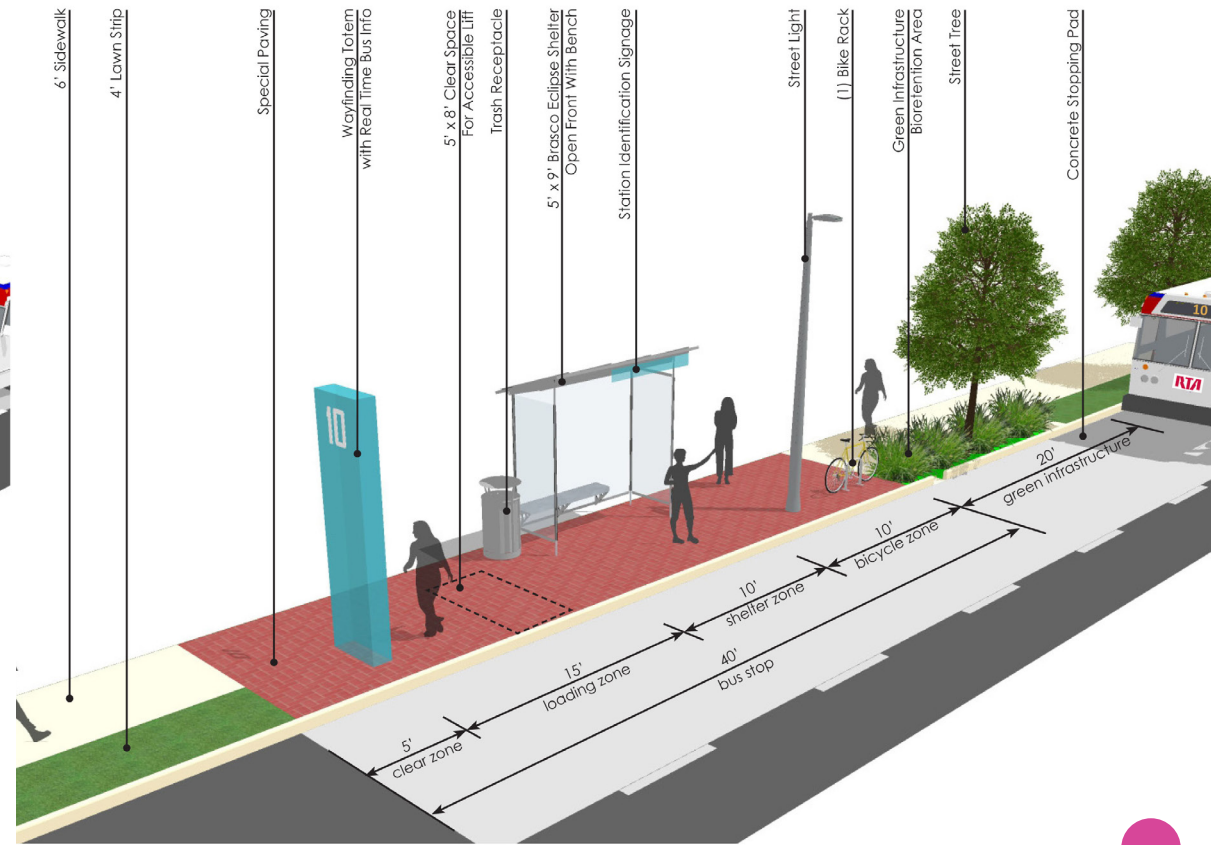

Narrow Station



The following images and specifications identify the basis of design for future bus waiting area amenities. The most important being the transit shelter. Envisioned to be an adaptation of Brasco International's Eclipse Flat model, the bus stop shelter will be designed to be lit, include a translucent tinted roof for shade and illumination, integrated signage, seating and leaning features and be able to support WiFi connectivity in the future.

Additionally, the waiting areas will include an illuminated marker pylon that displays route information. The downstream side of the pylon can support advertising if desired by RTA. The pylon and integrated signage will include accent colors specific to individual neighborhoods. The map on the following page illustrates then locations of the accent colors.

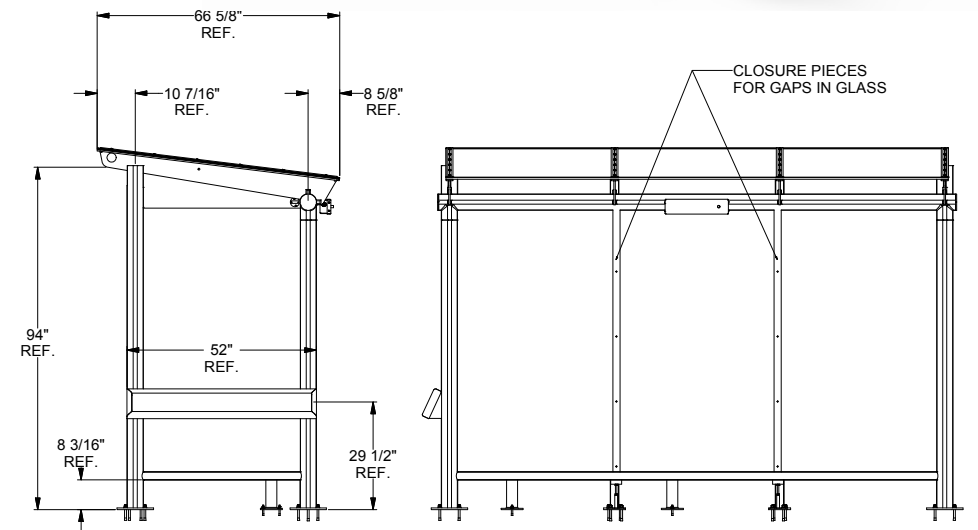
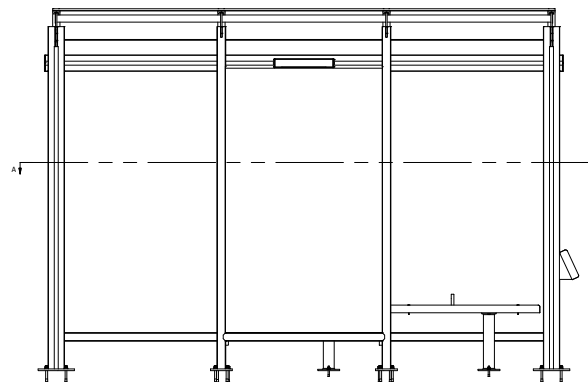
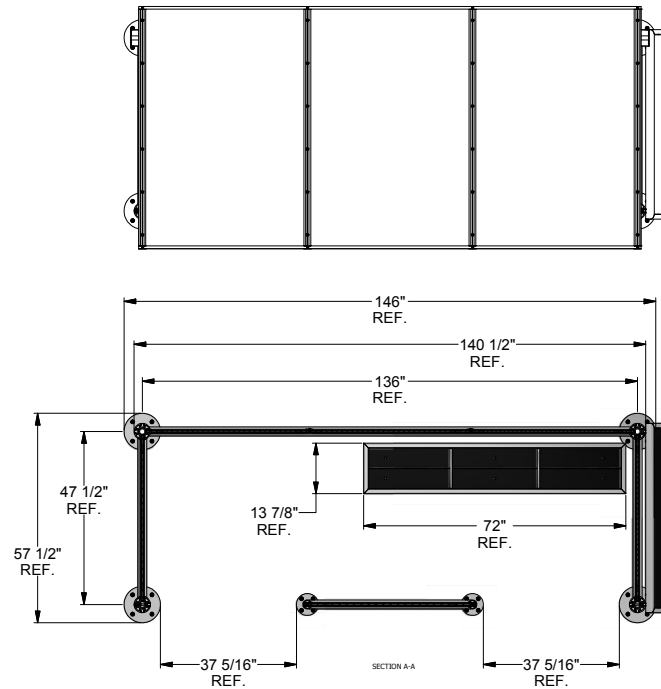



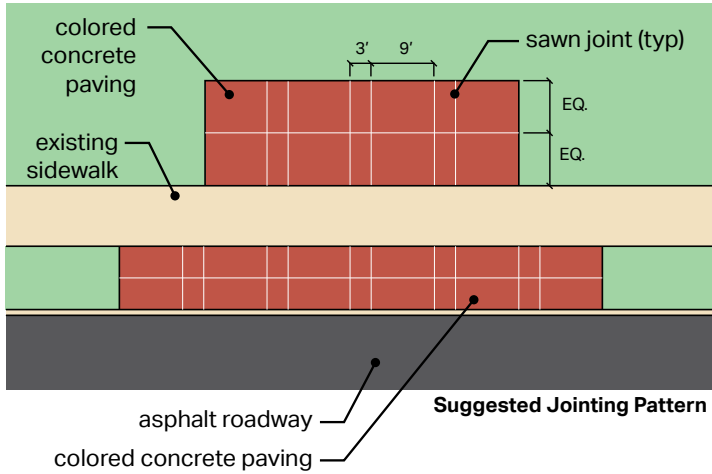

CHROMIX
ADMIXTURES for Color-Conditioned® Concrete

Add strength and beauty to both vertical and horizontal construction projects with CHROMIX Admixtures. The reliable, non-fading and consistent coloring admixtures for cast-in-place and precast concrete have been proven to stand the test of time.

Available in two convenient forms:

- CHROMIX P (powdered)
- CHROMIX L (liquid) available through selected ready-mix suppliers and distributors in buckets and totes.

The most popular colors are shown on this color chart. More than 800 color formulations are readily available, in addition to our custom matching service.

Beauty, Durability and Value CHROMIX Admixtures provide streak-free color conditioning and performance characteristics superior to concrete colored with pigments.

LITHOCHROME® Colorwax™ and COLORCHURE® Concrete Sealer are available in matching colors.

SCOFIELD® Texturetop® is also available in colors to approximate those shown.

Review Tech-Data Bulletins and MSDS before use. Visit www.scfield.com for the most current versions.

C-31 Shadow Gray	C-28 Saturated Clay	C-23 Coral Red	C-26 Antique Oak
K-218-8 Landmark Gray	603 Winter Beige	C-32 Quarry Red	524 Summer Beige
136 Cool Gray	626 Autumn Beige	589 Concrete Red	913 Spring Beige
C-14 Fresh Gray	C-25 Linestone	C-27 Weathered Brown	C-15 Cashella Sand
C-24 Charcoal	C-28 Sandstone Buff	187 Barcelona Brown	C-11 Desert Sand
C-24 Dark Gray	C-12 Moss Beige	189 Bronzstone	C-21 Adobe Tan

Basis of design illustrations and specifications for the bus waiting area pads using integrally colored concrete.



Litter Receptacle
Unit Price: \$1800

Basis of Design
Manufacturer: Victor Stanley
Model: A-36
Color: Silver



Backless Bench
Unit Price: \$2500

Basis of Design
Manufacturer: Victor Stanley
Model: FBF-36-Silverarm
Color: Silver



Bike Rack
Unit Price: \$1000

Basis of Design
Manufacturer: Landscape Forms
Model: 35-Loop-09
Color: Silver

Basis of design specifications for bus waiting area furnishings.

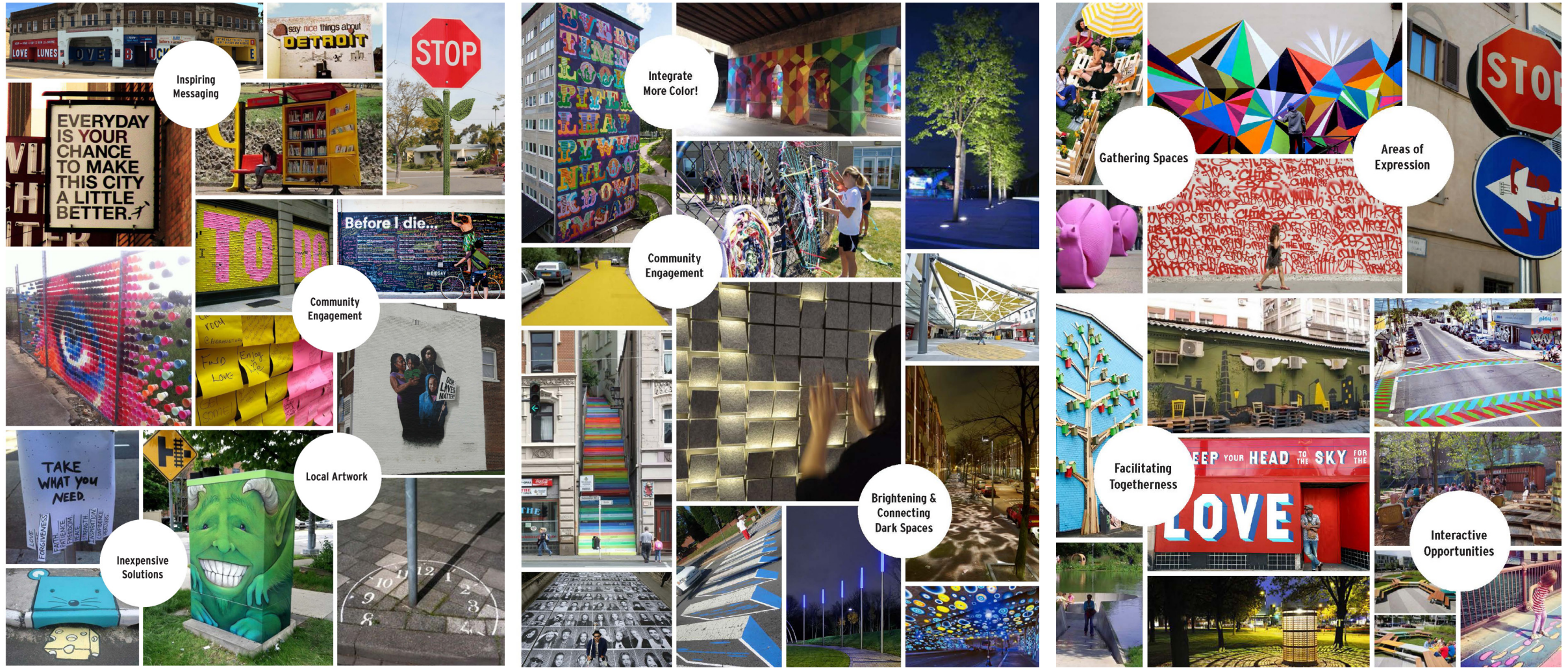

Imagery depicting the inspiration for public art expressions at bus waiting areas.

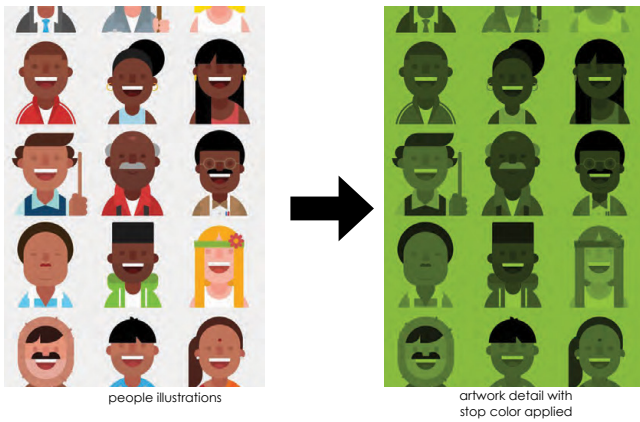

people illustrations

artwork detail with stop color applied

"FACES OF THE COMMUNITY" STATION ARTWORK

each neighborhood to get a different color theme (e.g. glenville = purple)
choose colors to compliment station totem/signage



community member photo

dot artwork detail

"FACES OF THE COMMUNITY" STATION ARTWORK

each neighborhood to get a different color theme (e.g. glenville = purple)
choose colors to compliment station totem/signage



corner parklet art screens with student/community artwork + dot faces



shelter artwork



Station elements, like seating and crosswalks use station color to tie-in to community color palette



shelter artwork



landscape fence with dot faces (or local artwork) around green infrastructure

Additional improvements include integrating artwork into the bus stops. Elements of the artwork are distilled from the community images. Through stakeholder and neighborhood workshops an idea emerged to showcase the faces and voices of each community as inspiration for the public art at each bus stop. This idea had its roots in early discussions of public safety where the corridor communities noted that the "good people" of the

neighborhood made them feel safe. Integrating the faces and voices into the bus waiting areas surrounds residents and visitors with the "good people" of the corridor. The artworks range from post-processed community members' photo, group action silhouettes, and illustrations of people in different color themes, to word clouds emphasizing neighborhood characteristics.



community member photos (each group chooses a theme or action)



convert photos to silhouettes



corner parklet artwork

"FACES OF THE COMMUNITY" STATION ARTWORK

each neighborhood to get a different color theme (e.g. teal = university circle)
choose colors to compliment station totem/signage

SUBURBS AGRICULTURE PARKS FAMILY INDUSTRY
UNION MILES **PARKS** **FAMILY** **KINSMAN**
 THE 10 LUKE EASTER PARK COMMUNITY
 KINSMAN AVENUE CHURCH OF GOD

group of words (adjectives, places, neighborhood assets, etc) arranged in a pattern strip

"VOICES OF THE COMMUNITY" STATION ARTWORK

each neighborhood to get a different color theme (e.g. glenville = purple)
choose colors to compliment station totem/signage

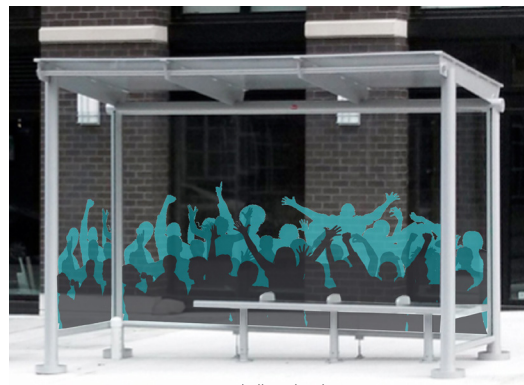

shelter artwork



landscape fencing with silhouette cutouts around green infrastructure



shelter artwork



Station elements, like sidewalks and fences use station color to tie-in to community color palette and "voices" theme

These images illustrate four explorations of how the faces and voices of each neighborhood could be used as the inspiration for public art at each bus waiting area.

+ The Street

Throughout the planning process and consultations with communities, one question was constantly asked: “how can the street help?” More specifically- how can redesigning the street help meet neighborhood priorities of public safety, pedestrian comfort and convenience, an enhanced #10 experience, and of catalyzing economic development? Collaborative discussions regarding trade-offs and preferences led to the following priorities for each segment.

Overall Design Priorities

Improvements that directly enhance public safety, comfort, and convenience will be present throughout all segments. These ideas include the installation of pedestrian level lighting and street trees, the creation of social gathering spaces for residents of all ages, information access through wayfinding signage and WiFi access, and enhanced visibility crosswalks. Strategic utility undergrounding will be an important part of transforming the function and aesthetic appeal of the corridor.

Northern Corridor priorities

The northern segments of E 105th Street will prioritize expanded sidewalk space for pedestrians, especially at signature intersections.

Opportunity corridor segment priorities

Within the portion of E 105th Street that overlap with the Opportunity Corridor, the emphasis will be on creating signature intersections and crosswalks that better connect the Fairfax neighborhood to the west with the New Economy neighborhood to the east.

Woodhill Rd and E. 93rd Street segment priorities

Within the southern half of the corridor, the right of way is wider and can accommodate an increased number of amenities. In these areas the priority will be to expand pedestrian space and provide the bicycle connectivity that has been previously planned by the City. This segment can also provide dedicated lanes for improved bus service during the peak period.

Streetscape Typologies

During the design workshop with city and neighborhood stakeholders, GCRTA, the public at large and the design team, a number of streetscape typologies were developed to achieve the stated priorities above. They were based upon the 60’ minimum width of the northern E 105th Street right of way and the 70’ minimum width right of way of the southern Woodhill Rd and E 93rd Street rights of way. In each case expanded pedestrian space was needed.



70' Right of Way with Cycle Track

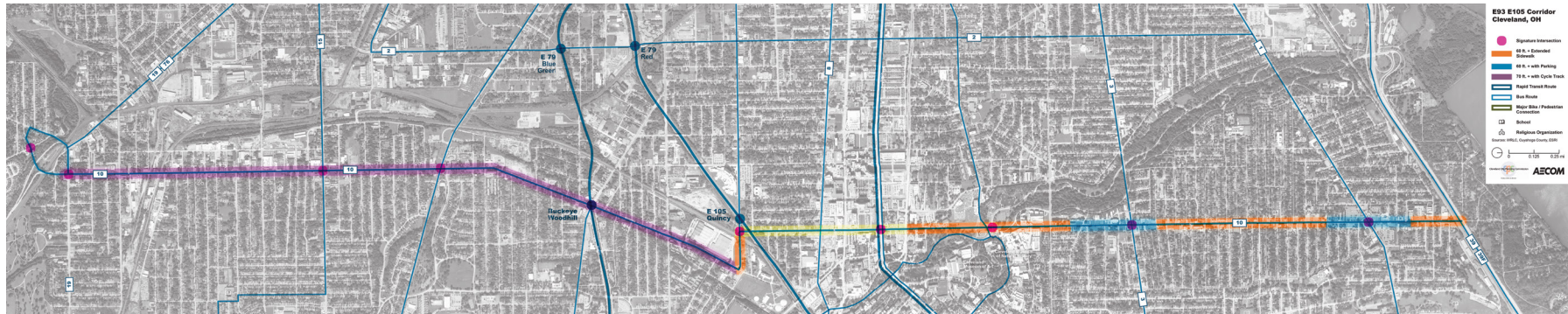

Diagram depicting the locations of each streetscape typology



60' Right of Way with On-Street Parking



60' Right of Way with Expanded Sidewalk

Simultaneously traffic counts and crash data obtained from NOACA suggested that the four lane cross-section of the corridor was more street than needed in most locations. The locations that merited four lanes overlapped with the Opportunity Corridor work currently under construction. In all other cases, a three lane section that incorporates a center turning lane can meet the current and future needs of vehicles. This road diet can support the expanded pedestrian space goals as well as make room for needed street trees, social space and reduced crossing widths that enhance aging-in-place scenarios.

60' Typologies

Two design typologies are shown for the 60' minimum width segments of E 105th Street. The Expanded Sidewalk typology would be most appropriate adjacent to signature intersections where the most pedestrian circulation space is needed. In these areas parking needs will be met by off street parking lots. The on-street parking typology would be most appropriate mid-segment where on street parking on one side can benefit local businesses. Bump-outs at intersections can reduce crossing widths or facilitate bus stops.

70' Typologies

These segments have greater right of way width and as such allow additional flexibility. The desired section includes four travel lanes and a protected cycle track along the East side of the street. In areas with greater width, additional space can be provided in the planting areas. This section allows for the possibility of dedicated corridor BRT lanes during the peak period.

Additional amenity features

Additional amenities will be part of the streetscape at appropriate locations.

Outdoor living rooms

Outdoor living rooms will function as community social spaces and include shaded seating areas, special paving and opportunities for integrated public art. These places will help support local businesses and provide each neighborhood with opportunities to customize the street to their needs.

Green infrastructure

Green infrastructure will be a critical component of the streetscape implementation. In the appropriate locations, curbside bio-retention systems, infiltration areas or below grade detention systems can be employed to improve water quality and manage its quantity. These facilities can be plugged into each typology at points that properly intercept run-off.

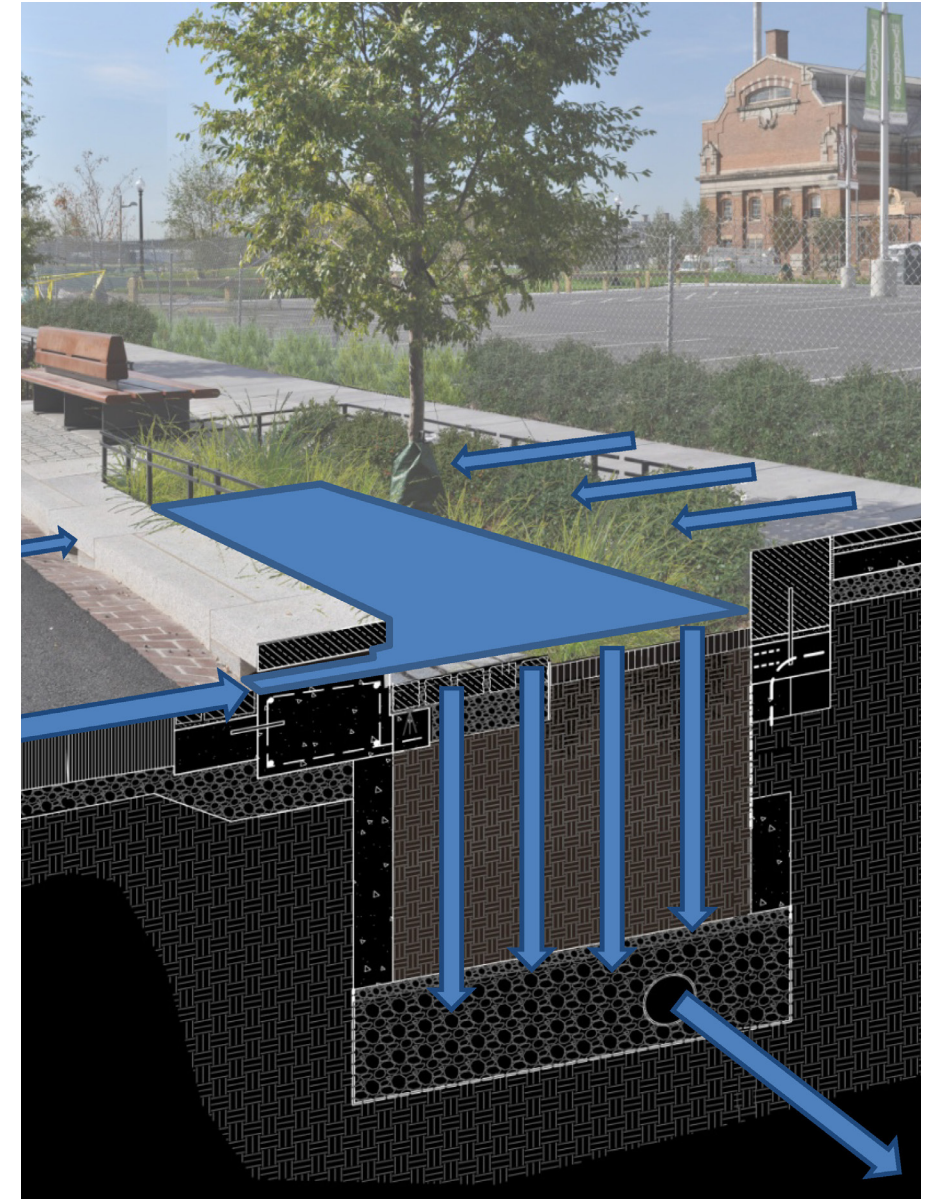

Illustration of typical curbside bio-retention green infrastructure.

DECORATIVE CROSSWALKS

Colored Asphalt + White Thermoplastic Piano Key Striping (ODOT Standard)

Heat-fused Thermoplastic Unit Price: \$16/ SF

Colored Asphalt Unit Price: \$16/ SF

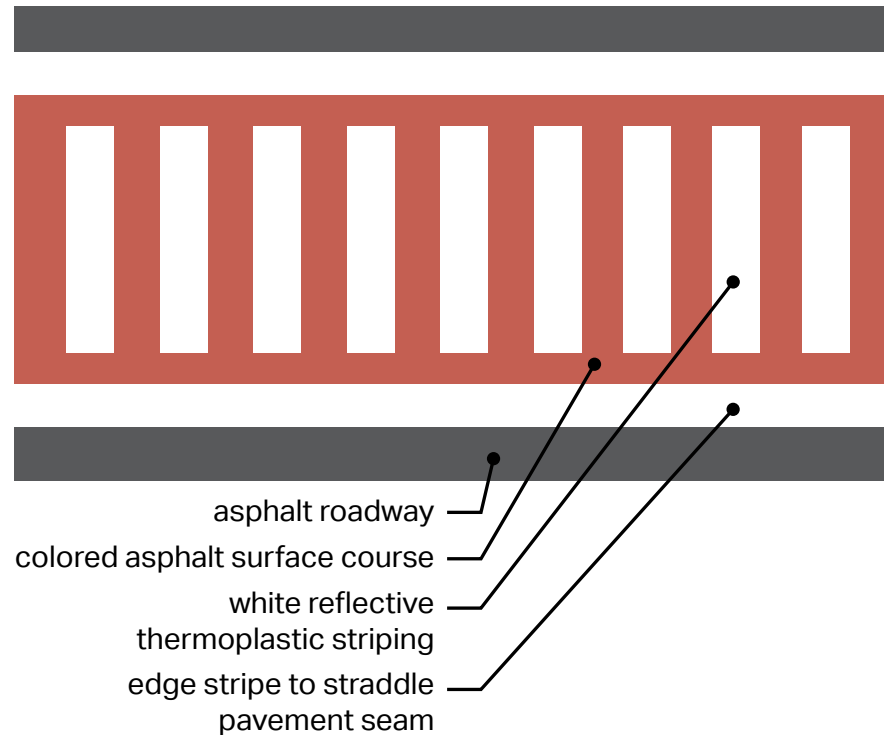

Longevity = Same as Roadway Surface
 Durability = High
 Color Retention = Good
 Compatible with Standard ODOT Markings = Yes
 Art or Pattern = No

Color Palette

Note: The colors presented on this chart are representations. Actual color of manufactured product may vary slightly from the chart.
 Remarque: Les couleurs ne sont présentées sur ce tableau qu'à titre d'exemples. Les couleurs du produit final peuvent varier légèrement.
 Observación: Los colores que son presentados en este cuadro son a título de ejemplo. Los colores del producto final pueden variar ligeramente.

Old Brick	Chocolate	Sierra	Bedrock	Burnt Sienna
Terra Cotta	Brick Red	Nutmeg	Taupe	Khaki
Desert Buff	Irish Cream	San Diego Buff	Sunset Blush	Sandstone
Fawn	Natural Cement	Pewter	Granite	Slate
Forest Green	Safety Blue	Yellow	Charcoal	White

Basis of design Illustrations and specifications for typical decorative crosswalk treatments throughout the corridor.

+ Bikeway Concepts

Bikeway concepts were developed and evaluated as part of the E 105th - E 93rd Street corridor study. The process began with the assessment of existing and planned bikeways within and near the corridor study area as documented in the City’s Bikeway Master Plan. Some sections of the E 105th - E 93rd Street corridor are identified with proposed bicycle facilities, including E 93rd Street north of Mt Auburn Avenue and Woodhill between Mt Auburn Avenue and Quincy Avenue, however the facility type is not designated. Recent bikeway planning initiatives such as the East Side Greenway Plan and the Midway Cycle Track Plan were also reviewed for relevance to this project.

The northern portion of the corridor, E 105th Street north of Quincy Avenue, is narrower and has a more urban context than the southern portion extending south along Woodhill Road and E 93rd Street. E 105th Street is not wide enough to accommodate a separately designated bicycle facility while maintaining through traffic movement. In addition, this section of the corridor benefits from existing and planned parallel bikeways, and requires more space to accommodate pedestrians and bus stops. As such, sharrows are proposed as an acceptable bikeway treatment for E 105th Street north of Quincy Avenue. This treatment would be implemented to the north of the section of E 105th Street that is included in the Opportunity Corridor.

The southern portion of the corridor, Woodhill Road and E 93rd Street between Quincy and Broadway Avenues, is an important north-south travel corridor within the east side of Cleveland. It provides the opportunity for a much needed north-south multi-modal connection. This section of the corridor connects to multiple neighborhoods and links with existing and planned bicycle infrastructure. A bikeway facility along E 93rd Street-Woodhill would facilitate the connection to University Circle, which currently feels farther than the actual distance due to the existing infrastructure. The E 93rd Street-Woodhill corridor potentially could connect to the Lake-to-Lakes Trail (along Stokes Blvd - Fairhill Road) and the Harrison Dillard Bikeway via the Baldwin Water Treatment Plant.

Additionally, with a right-of-way width of approximately 70 ft, E 93rd Street-Woodhill is wide enough to be reconfigured to accommodate a separately designated bicycle facility. A cycle track will better integrate with transit operations compared to bike lanes as buses will physically block bike lanes at bus stops, thus creating a safety concern. This issue is mitigated with the proposed cycle track. Bus stops along the cycle track side of the corridor would be positioned on the road side of the cycle track, with shelters incorporated into the proposed buffer between road and cycle track. By design, the cycle

track physically separates bicycles from vehicles, however, intersection and driveway treatments will require attention to ensure safe operations for bicycles and vehicles. Traffic movements must be designated and sight lines between drivers and cyclists must be clear.

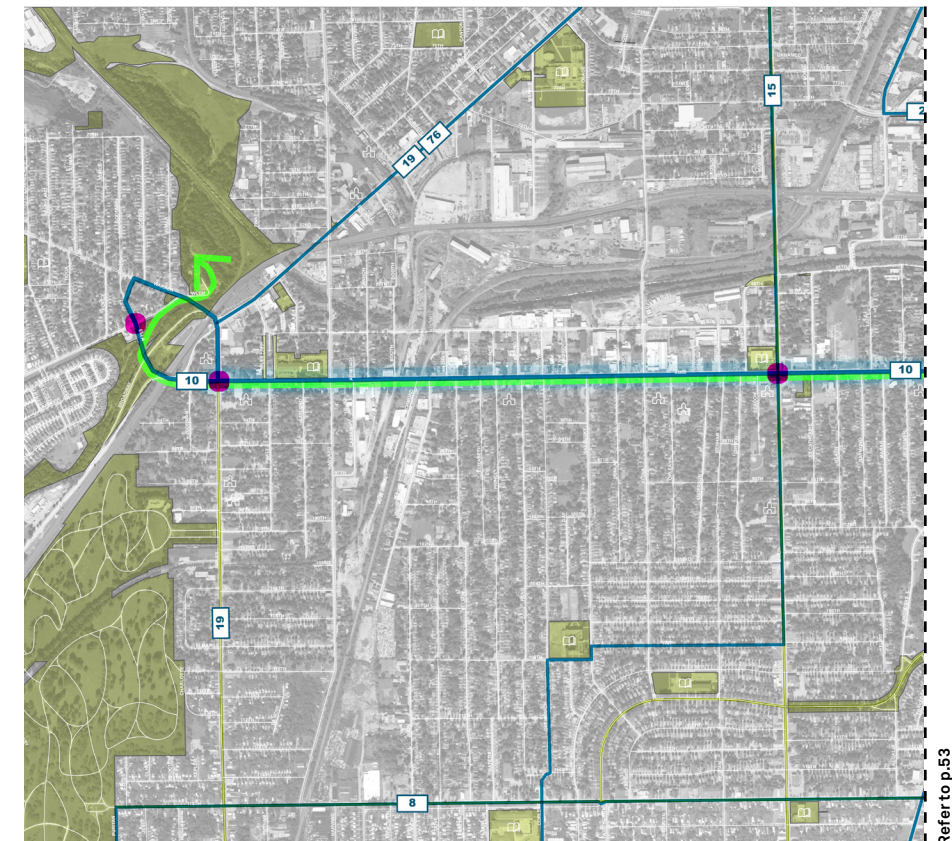

Cycle tracks have been successfully implemented in multiple cities throughout the United States and the world. Design standards and guidelines are provided by AASHTO and ODOT roadway standards and guidelines. Additional examples of current practices related to two-way separated

bicycle facilities and intersection concepts are provided in the NACTO bikeway design guide. Design elements and standards for a two-way separated bikeway, and NACTO standards for a corridor combining auto, transit and bikeway elements are shown in the adjacent images.

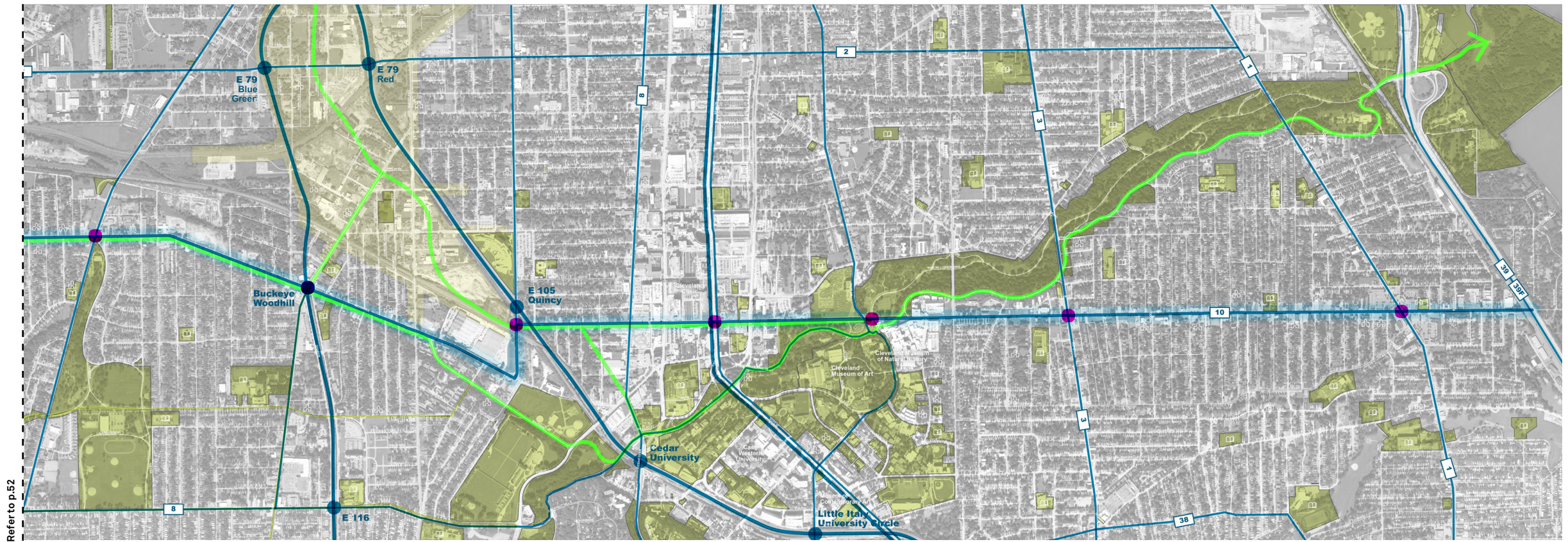

Diagram depicting the proposed bicycle connectivity

The City of Indianapolis implemented a cycle track network in the greater downtown area. The Indianapolis Cultural Trail provides an example in a city that is fairly similar to Cleveland. In downtown Indianapolis, the Indianapolis Cultural Trail is constructed adjacent to and at the same level as the sidewalk with high quality streetscape. Other sections that connect to the Indianapolis Cultural Trail, like the Shelby Avenue cycle track, are constructed alongside the roadway within the street's paved area. Photographs of various elements of bicycle and pedestrian elements of the Indianapolis Cultural Trail are provided.

The sidewalk and street level cycle track concepts that have been implemented in Indianapolis provide design examples for Cleveland. Regardless of the specific type of cycle track design selected for the E.93rd Street-Woodhill Road corridor, the following elements will need to be considered as part of the design:



Indianapolis Cultural Trail
(sidewalk level cycle track)

The City of Columbus created protected bike lanes along the 1.4-mile portion of Summit Street between Hudson Street and 11th Avenue in the University District. The existing and proposed lane configuration of Summit Street in this area is shown in this chapter, and an illustration of the proposed configuration, including location of bus stop improvements in the corridor, is shown as well. The two lanes allow for northbound and southbound cyclists and are located along the west side of Summit Street. Each lane is 5 feet wide and there is a 2 foot buffer zone, posts, and a new parking lane separating the bike lanes from the traffic lanes. There are also single, unprotected bike lanes that continue south of 11th Avenue through Weinland Park, Italian Village, and Downtown and on Fourth Street from Hudson to the southern edge of Downtown. Other new bike infrastructure is also included in the construction in the form of “bus bulbs” that allow pedestrians to board buses without conflicting with bike-lane traffic, and “queue boxes” that enable cyclists to turn left on busy streets and to pass cars merging onto freeway ramps in a safer and easier manner.



Cycle Track Transit Treatments

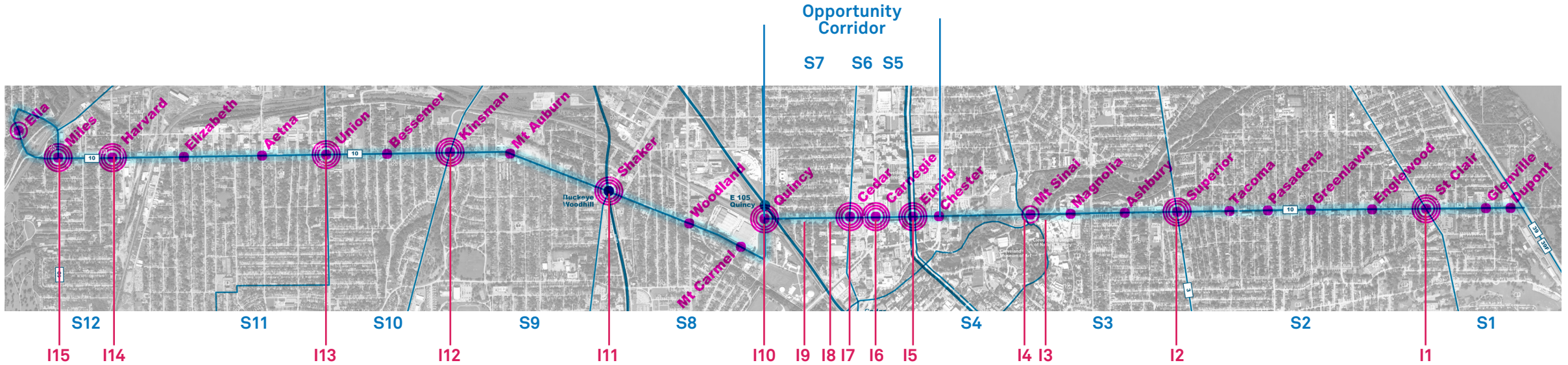

Diagram depicting locations of intersections and segments related to the capital budget.

+ Implementation

Implementation of corridor improvements should be an exercise in equitable community enhancement, public investment to leverage economic development, and advantageous coordination with parallel projects. All three factors must be weighed in determining the optimal approach to funding, timing and construction. The following diagram and table depicts the location of key segments (S) and intersections (I) for implementation and their rough order of magnitude costs. The table also includes a suggested phasing strategy for consideration.

The phasing strategy prioritizes two concepts:

Implement signature intersections throughout the entire corridor

These locations are the points of highest visibility and function and they, and their bus stops play a critical role in improving the #10 transit transfer experience. The intersections have a unique potential to improve public safety, amenity and perception in all corridor neighborhoods.

Implement the segments adjacent to the current Opportunity Corridor construction

These segments offer the nearest-term economic development opportunity and can be used to maintain the momentum of current investment outward from University Circle into the corridor neighborhoods.

The later phases include the remaining segments that connect between earlier developed intersections, completing the system.

Summary of Probable Construction Costs - Conceptual

No.	Description	Cost	Phasing of Implementation		
			Priority I	Priority II	Priority III
S1	Segment from Elk Avenue to St. Clair Avenue	\$2,255,000			
I1	Intersection at E 105th Street and St. Clair Avenue	\$1,020,000			
S2	Segment from St. Clair Avenue to Superior Avenue	\$8,053,000			
I2	Intersection at E 105th Street and Superior Avenue	\$1,020,000			
S3	Segment from Superior Avenue to Martin Luther King Jr. Drive	\$4,330,000			
I3	Intersection at E 105th Street and Martin Luther King Jr. Drive	\$62,000			
I4	Intersection at E 105th Street and Mt. Sinai	\$276,000			
S4	Segment from Martin Luther King Jr. Drive to Euclid Avenue				
I5	Intersection at E 105th Street and Euclid Avenue	\$225,000			
S5	Opportunity Corridor				
I6	Intersection at E 105th Street and Carnegie Avenue	\$110,000			
S6	Opportunity Corridor				
I7	Intersection at E 105th Street and Cedar Avenue	\$110,000			
I8	Intersection at E 105th Street and Wain Court	\$912,000			
I9	Intersection at Future Urban Neighborhood	\$912,000			
S7	Opportunity Corridor				
I10	Intersection at E 105th Street and Quincy Avenue	\$225,000			
S8A	Segment from E 105th Street to Woodhill Road on Quincy Avenue	\$626,000			
S8B	Multi-use path from Quincy Avenue to Stokes Boulevard	\$311,000			
S8C	Segment from Quincy Avenue to Shaker Boulevard / Buckeye Road	\$7,186,000			
I11	Intersection at Woodhill Road and Shaker Boulevard / Buckeye Road	\$225,000			
S9A	Segment from Shaker Boulevard / Buckeye Road to Mt. Auburn Avenue	\$4,513,000			
S9B	Segment from Mt. Auburn Avenue to Kinsman Road	\$2,562,000			
I12	Intersection at E 93rd Street and Kinsman Road	\$1,020,000			
S10	Segment from Kinsman Road to Union Avenue	\$5,048,000			
I13	Intersection at E 93rd Street and Union Avenue	\$1,020,000			
S11	Segment from Union Avenue to Harvard Avenue	\$8,795,000			
I14	Intersection at E 93rd Street and Harvard Avenue	\$1,020,000			
S12	Segment from Harvard Avenue to Miles Avenue	\$1,955,000			
I15	Intersection at E 93rd Street and Miles Avenue	\$1,020,000			

Estimated Totals

Estimated Subtotal	\$54,811,000
Inflation (2017 to 2022)	\$10,578,523
Construction Engineering	\$6,538,952
Probable Construction Cost	\$71,929,000
Probable Right of Way Cost	\$0
Total Capital Cost	\$77,160,000
Allowance for branded bus augmentation	\$2,840,000
Total Cost	\$80,000,000

Table listing breaking down cost of corridor improvements within the right of way.



+ Funding Thrive 105

Thrive 105 advances a corridor bus rapid transit project that would connect major east-west bus and rail rapid transit routes. It is anticipated that the bus rapid transit service improvements will build ridership over time by making cross-town bus connections more convenient through increased service frequency, improved travel times, branded identity, enhanced stations and waiting areas and improved pedestrian access.

This preliminary Funding Plan charts a realistic and achievable course for a sustainable Thrive 105 corridor bus rapid transit service that will be the foundation for growth and development in the study area and the City. This framework supports advancement of the Thrive 105 corridor bus rapid transit (BRT) service by aligning funding sources with the estimated capital and operating costs to implement the BRT service in the corridor. Funding considerations discussed are preliminary and should be considered dynamic at this stage of project planning, especially given the current proposals by the Trump Administration to eliminate both the TIGER and federal transit Capital Investment Grant programs, which heretofore have been an important source of investment capital for public transit infrastructure projects.

This funding plan assumes Congress will continue to appropriate funds for the TIGER and Capital Investment Grant program and other existing transportation grant programs as outlined in Fixing America's Surface Transportation Act (FAST Act). Under existing law, the

Thrive 105 corridor BRT would qualify for TIGER and federal transit Capital Investment Grant funding under certain circumstances. These features and design elements will be discussed. As the Capital Investment Grant program as it may not be funded in future, An alternative funding strategy is outlined as well.

Project Costs

Project costs are broken down into both capital expenditures (CAPEX) and operating and maintenance expenditures (OPEX).

CAPEX

Costs to construct the Thrive 105 corridor BRT improvements have been identified and are estimated to be approximately \$80 million (2017 dollars). These capital costs may be eligible for a variety of federal grant programs as described below.

OPEX

Cost to operate and maintain the increased service frequencies have not been determined. But these costs would have to be borne by the Greater Cleveland Regional Transit Authority (RTA) as the system operator. The primary sources of operating revenue are sales tax receipts and farebox revenue. RTA derives about 70 percent of its operating revenue from a 1 percent ad valorem sales tax and about 20 percent from farebox receipts. The balance comes from other federal reimbursements and advertising. Almost zero operating assistance comes from state sources.

Federal Funding Sources

The single largest source of funding for transportation projects stems from federal legislation. Fixing America's Surface Transportation (FAST) Act (Pub. L. No. 114-94) became law in December 2015, which was the first federal law in over a decade to provide long-term funding certainty for surface transportation infrastructure planning and investment. The FAST Act authorizes \$305 billion over fiscal years 2016 through 2020 for highway, highway and motor vehicle safety, public transportation, motor carrier safety, hazardous materials safety, rail, and research, technology, and statistics programs. The FAST Act maintains a focus on safety, keeps intact the established structure of the various highway and transit-related capital grant programs. Congress must appropriate funds each fiscal year. The Trump Administration has proposed not funding several programs as indicated earlier. The following is a summary of transportation related grant programs under the FAST Act that could be available for funding portions of the Thrive 105 corridor BRT project.

Federal Highway Flexible Funding

There are several flexible funding programs available to fund transit related projects. Flexible funds are certain legislatively specified funds that may be used either for transit or highway purposes. The idea of flexible funds is that a local area can choose to use certain federal surface transportation funds based on local planning priorities, not on a restrictive definition of program eligibility. Flexible funds include Federal Highway Administration (FHWA) Surface Transportation Block Grant (STBG) funds and

Congestion Mitigation and Air Quality Improvement Program (CMAQ) and FTA Urban Formula Funds. Flexible funding allows for the innovative use of FTA and FHWA funds to create livable communities.

The FAST Act converts the long-standing Surface Transportation Program (STP) into the Surface Transportation Block Grant Program (STBG), acknowledging that this program has the most flexible eligibilities among all Federal-aid highway programs and aligning the program's name with how the Federal Highway Administration (FHWA) has historically administered it. The FAST Act provides an estimated annual average of \$11.7 billion for STBG, which States and localities may use for projects to preserve or improve conditions and performance on any Federal-aid highway, bridge projects on any public road, facilities for non-motorized transportation, transit capital projects, and public bus terminals and facilities. The FAST Act authorizes a single lump sum for all apportioned programs under 23 U.S.C § 104. The authorized lump sum is first distributed among all the states based on each state's fiscal year combined apportionments. The amount determined for each state is then distributed within that state among its apportionment programs.

Funding for Transportation Alternatives (TA) is set aside from the overall STBG funding amount. After accounting for this set-aside, FHWA distributes a percentage of a State's STBG funds based on population (sub-allocated), and the remaining funds are available for use anywhere in the State. The sub-allocated percentage starts at 51 percent in FY 2016, and then grows each year, to 55 percent in FY 2020.

Moving funding from highway projects to transit projects is authorized by the FAST Act. To transfer the funds from a highway project to a transit project the Ohio Department of Transportation (ODOT) must send a request for the transfer, with concurrence from the Northeast Ohio Areawide Coordinating Agency, the Greater Cleveland's Metropolitan Planning Organization (MPO), to the FHWA Division Office. When these funds are spent directly on transit or transferred to FTA from FHWA, they are primarily used for transit capital projects, such as vehicle purchases, transit infrastructure construction, and finance costs for eligible capital projects.

When states or urbanized areas use flex funding on transit projects, they may leave the funds in the state's FHWA account, in which case the state receives reimbursement from FHWA as costs are incurred. Federal laws and regulations require that projects proposed for highway and transit funding be based on comprehensive metropolitan and statewide transportation planning processes. State, regional, and local government agencies and transit operators must operate within these requirements to receive Federal funds. To receive Federal funding, projects must be included in a state transportation improvement program that demonstrates sufficient funds are available to implement the project or program.



Congestion Mitigation and Air Quality Improvement Program (CMAQ)

Another great source of flexible funds for FTA projects is CMAQ, which has the objective of improving the Nation’s air quality and managing traffic congestion. CMAQ projects and programs are often innovative solutions to common mobility problems and are driven by Clean Air Act mandates to attain national ambient air quality standards. Eligible activities under CMAQ include transit system capital expansion and improvements that are projected to realize an increase in ridership; travel demand management strategies and shared ride services; pedestrian and bicycle facilities and promotional activities that encourage bicycle commuting. When these funds are spent directly on transit or transferred to FTA from FHWA, they are primarily used for transit capital projects, such as vehicle purchases, transit infrastructure construction, and finance costs for eligible capital projects. In addition, CMAQ funds transferred to FTA may be used for operating costs for new or expanded services for a limited duration.

Transportation Investment Generating Economic Recovery Discretionary Grant

The TIGER Discretionary Grant program provides a unique opportunity for communities to invest in a variety of transportation infrastructure projects that deliver significant economic benefits. The eligibility requirements of the TIGER grant program allow project sponsors to obtain funding for multi-modal, multi-jurisdictional projects that are more difficult to support through traditional federal grant programs. Awards have recently focused on capital

projects that generate economic development and improve access to reliable, safe and affordable transportation for communities. Thrive 105 was a recipient of \$500,000 TIGER planning grant. Atlanta received a \$47 million TIGER grant to assist the city in building a new streetcar line. TIGER grants to fund corridor BRT projects in Birmingham, Louisville, Omaha and Richmond have ranged between \$10 and \$25 million.

Federal Transit Funding

There are a variety of federal transit grant programs available to transit agencies to fund projects. The two most used funding vehicles are the discretionary capital Investment Grant Program and the discretionary portion of the Bus and Bus facilities grant programs. Other funds are available to transit systems by formula apportionment as appropriated by Congress.

Capital Investment Grants (Section 5309)

The Capital Investment Grant (CIG) Program outlined in 49 USC 5309 also was authorized in December 2015 by the FAST Act until 2020. The CIG Program is the Federal Transit Administration’s primary financial resource for supporting transit capital projects that are locally planned, implemented, and operated. It provides funding for fixed guideway investments such as new and expanded heavy rail, commuter rail, light rail, streetcars, bus rapid transit, and ferries as well as corridor-based bus rapid transit investments that emulate the features of rail. The Trump Administration is proposing not to fund this program under its FY2018 budget proposal, except for those projects previously approved for Full Funding Grant Agreements.

There are three categories of eligible projects under the CIG program: New Starts, Small Starts, and Core Capacity. New Starts and Core Capacity projects are required by law to go through a three phase process - Project Development, Engineering, and Construction. Small Starts projects are required by law to go through a two phase process - Project Development and Construction.

As defined in FAST, New Starts projects are those whose sponsors request \$100 million or more in Capital Investment Grant Program funds or have an anticipated total capital cost of \$300 million or more. Core Capacity projects are substantial investments in existing fixed guideway corridors that are at capacity today or will be in five years, where the proposed project will increase capacity by not less than 10 percent. Small Starts projects are those whose sponsors request less than \$100 million in Capital Investment Grant Program funds and have an anticipated total capital cost of less than \$300 million.

All CIG projects must be evaluated and rated on a set of statutorily defined project justification and local financial commitment criteria and receive and maintain a “Medium” or better overall rating to advance through the various phases and be eligible for funding. Ratings are point in time evaluations by FTA and may change as the proposed project proceeds through planning and design when information concerning costs, benefits, financial plans, and impacts is refined.

The Thrive 105 corridor BRT project is transit and transit access improvements are estimated to cost \$50 million. Additional proposed non-transit related improvements will

cost approximately \$30 million. This would categorize it as a Small Start project. Thrive 105 would qualify for up to \$25 million of Small Starts Funding (for transit and transit access related improvements costing \$50 million) if the project design and service plan contained the following features and elements:

- + The route must provide short headway, bidirectional service for at least a fourteen-hour span of service on weekdays and a ten-hour span of service on weekends. Short headway service on weekdays consists of either (a) fifteen-minute maximum headways throughout the day, or (b) ten-minute maximum headways during peak periods and twenty-minute maximum headways at all other times. Short headway service on weekends consists of thirty-minute maximum headways for at least ten hours a day.
- + The route must have defined stations that comply with DOT standards for buildings and facilities under the Americans with Disabilities Act, offer shelter from the weather, and provide information on schedules and routes.
- + The route must provide faster passenger travel times through congested intersections by using active signal priority in separated guideway if it exists, and either queue-jump lanes or active signal priority in non-separated guideway.
- + The provider must apply a separate and consistent brand identity to stations and vehicles.

RTA operates Route 10 every 15 minutes in the peak and every 30 minutes the balance of the day. This does not comply with the FTA Small Starts requirement for 10 minute peak and 15 minute off-peak service. Increasing the frequency of service will require additional GCRTA operating expense. Thrive 105 corridor signage and new stations would comply with the branded identity requirements and all stations would be ADA compliant. The City controls traffic signals and this project could move forward in compliance with this requirement if the city agrees to transit priority treatments as required by the project eligibility criterion. The Thrive 105 project complies with all other FTA requirements for Small Starts funding.

Bus and Bus Facilities (Section 5339)

The federal transit grants for Buses and Bus Facilities program makes federal resources available to replace, rehabilitate and purchase buses and related equipment and to construct bus-related facilities including technological changes or innovations to modify low or no emission vehicles or facilities. Funding is provided through formula allocations and competitive grants. A sub-program, the Low- or No-Emission Vehicle Program, provides competitive grants for bus and bus facility projects that support low and zero-emission vehicles. The competitive grant program could be used to supplement formula allocations to acquire low emission (hybrid-electric) buses branded for the Thrive 105 corridor BRT project.



State Funding Sources

The Ohio Public Transportation Grant Program, as authorized under Section 5501.07 of the Ohio Revised Code is to assist transit agencies in providing safe/reliable public transportation in Ohio. The program is divided into two programs – Urban Transit Program and Rural Transit Program. Thrive 105 would qualify for funding under the Urban Transit Program. These funds are appropriated by the State Legislature.

The amount of funds Ohio designates to support public transportation has changed significantly over the past decade. In 2000, the State of Ohio contributed roughly \$43 million through the General Revenue Fund to public transportation. Today, the state provides just over \$7 million a year for public transportation through the General Revenue Fund (GRF), a slight increase over last year.

The state does supplement the GRF assistance by flexing FHWA funds to transit programs. The ODOT budget contains \$33 million in flex funds, as recommended by the Governor and accepted by the legislature. When added to the GRF, this amounts to about \$40 million in annual transit assistance for capital projects.

Local Funding Sources

There are three primary sources of local funding for this project: The City of Cleveland, Cuyahoga County and the RTA. NOACA is a channel to FHWA flex funds and CMAQ funds previously discussed.

City of Cleveland

The City of Cleveland re-initiated the Capital Improvement Program in 2007 in order to better plan the public investments that are necessary to make Cleveland a great place to live, work and play. A capital improvement program forecasts a community’s infrastructure, facility and equipment needs, and creates a strategy for funding and implementing projects designed to address those needs. The City of Cleveland has budgeted \$8 million for Thrive 105, which would be about 10 percent of the total project cost.

Cuyahoga County

Working in cooperation with ODOT and NOACA, the County Engineer's Office manages a Capital Improvement Program (CIP) used for the planning of future road and bridge improvements. Most of the County Engineer's operations and infrastructure investments are financed in part by the Ohio Vehicle Registration Fee, County Permissive Motor Vehicle License Tax and available State Gasoline Tax allocated to the county by ODOT and available Federal highway and bridge grant programs administered by FHWA and ODOT. The county also works closely with local cities to cover the costs of roadway improvements.

Greater Cleveland Regional Transit Authority

The RTA maintains a state-of-good repair and expands system capacity through capital investments that are planned and programmed based on availability of funds from a variety of sources.

The Capital Fund includes capital projects funded from the Sales & Use Tax revenue. In general, these capital projects are less than \$150,000, have a useful life of less than 5 years, are routine in nature, and usually directly tie to daily operations. This Fund is subdivided into Routine Capital projects, for the acquisition of non-revenue vehicles and equipment, and Asset Maintenance projects, that include minor rehabilitation projects at Authority facilities.

The RTA Development Fund primarily includes capital projects with a value greater than \$150,000, a useful life greater than five years, and includes all of the large multi-year rehabilitation/reconstruction and expansion projects of the Authority. All grant-funded projects are accounted for in the RTA Development Fund and projects in this Fund are normally supported through various combinations of Federal and State of Ohio grants, local matches for these grants, debt service and/or 100 percent local funds. Seventy percent of the capital investment funds expended by RTA come from federal formula grants for equipment replacement and state-of-good repair.

When RTA implemented the Euclid Corridor “HealthLine” fixed-route BRT, about \$82.2 million came from the FTA “New Starts” program or about 48.8 percent of total project cost of \$200 million. The funding allocations and partners are depicted in the following chart:

**New Start Project
Euclid Corridor BRT "HealthLine"**

Source of Funds	Amount	Percentage
FTA New Starts	\$82.2	48.8%
Other federal	\$0.6	0.4%
ODOT	\$50.0	29.7%
GCRTA	\$17.6	10.5%
City of Cleveland	\$8.0	4.8%
NOACA	\$10.0	5.9%
Total New Start	\$168.4	100.0%
Enrichments	Amount	Percentage
City of Cleveland	\$31.6	100.0%
Total Project Cost	\$200.0	

Donor Grants

This funding source represents grants from various government and non-government organizations. These may be philanthropic institutions or corporate partners.



Suggested Funding Sources

The recommended funding strategy assumes pursuing CMAQ, FTA Small Starts, FHWA flex funds and TIGER grant monies for a majority of the project costs.

* Pursuing FTA small starts funds involves additional eligibility requirements and project cost FTA Small Starts implications include:

- + Need for branded buses (either new buses or refurbished/painted buses dedicated to corridor)
- + Need for Transit Signal Priority (TSP) system
- + Need for Queue Jump Southbound at E105th and Quincy
- + Need for dedicated lane for transit during peak hour on Woodhill and E 93rd.

Funding Plan

Additional corridor enhancement cost	\$30,000,000*
FTA transit + transit access related projected costs	\$50,000,000*

Source	Program	Funds
Federal \$ through State of Ohio	CMAQ	\$14,000,000
FTA	Small starts	\$25,000,000
FHWA	Flex funds	\$9,000,000
USDOT	Tiger grants	\$10,000,000
Donor grants	TBD	\$5,000,000
GCRTA	CIP funds	\$1,000,000
Ohio turnpike infra. Commission	Bonded revenue	\$4,000,000
Cuyahoga County	CIP funds	\$4,000,000
City of Cleveland	CIP funds	\$8,000,000
Total capital		\$80,000,000
Federal Funds %		60%

To advance this project toward implementation the City and RTA in joint partnership would have to complete all the environmental assessments required under the National Environmental Policy Act including developing or reviewing alternatives, selecting locally preferred alternative (LPA), and adopting it into fiscally constrained long range transportation plan. The project must be advanced to have sufficient engineering and design completed to obtain FTA approval to advance the project into Project Development. The City and RTA must have firm commitments of all non-Section 5309 Small Starts funding.

Should Capital Investment grant monies not be available, the alternative funding plan would rely more heavily on formula funds and donor grants. This funding plan assumes lower overall project costs as it does not necessitate FTA grant prerequisites.

Alternative Funding Plan

Project Costs		\$77,200,000
Source	Program	Funds
Federal \$ through State of Ohio	CMAQ	\$14,000,000
FHWA	Flex funds	\$25,000,000
Donor grants	TBD	\$22,200,000
Ohio turnpike infra. Commission	Bonded revenue	\$4,000,000
Cuyahoga County	CIP funds	\$4,000,000
City of Cleveland	CIP funds	\$8,000,000
	Total capital	\$77,200,000
	Federal Funds %	51%

Consultant Team



Peter Lawson Jones



TH

RI

105

93

VE